



FIRESAFE II ***Containment and Evacuation***

Final Report

Version 1.1 – December 2018



Contract No.: 2017/EMSA/OP/17/2017

Project Name: Second study investigating cost-efficient measures for reducing the risk from fires on ro-ro passenger ships (FIRESAFE II)

WP: Part 2: Containment and Evacuation

Project Partners: Bureau Veritas Marine & Offshore
RISE Research Institutes of Sweden, Fire Research
Stena Rederi

WP Leader: Bureau Veritas Marine & Offshore

Authors: Jérôme Leroux, Bureau Veritas Marine & Offshore
Pierrick Mindykowski, RISE Research Institutes of Sweden
Franz Evegren, RISE Research Institutes of Sweden
Lisa Gustin, Stena Rederi
Jérôme Faivre, Bureau Veritas Marine & Offshore
Mattias Frösing, Stena Rederi
Joacim Lottkärr, Stena Rederi
Kujtim Ukaj, RISE Research Institutes of Sweden
Blandine Vicard, Bureau Veritas Marine & Offshore

Disclaimer:

The information and views set out in this study are those of the author(s) and do not necessarily reflect the official opinion of EMSA. EMSA does not guarantee the accuracy of the data included in this study. Neither EMSA nor any person acting on EMSA's behalf may be held responsible for the use which may be made of the information contained therein.

Rev.	Date	Author(s)	Reason for issue
0	21/06/2018	See list of authors	Consolidated report Sent to EMSA for consideration
1.0	19/10/2018		Final deliverable sent to EMSA
1.1	19/12/2018		Revisions after receiving comments from EMSA

1 ABSTRACT

Fire and smoke containment are well known issues during fires in ro-ro spaces, especially in case of uncontrolled fires. Similarly, in some accidents, evacuation systems remained inoperative due to the heat and flames coming through the openings of the ro-ro spaces.

This report presents a Formal Safety Assessment on containment and on evacuation following a ro-ro space fire incident on any ro-ro passenger ship.

The safety level was estimated for three generic ships representing the world fleet of RoPax ships (Cargo, Standard and Ferry RoPax) and a cost-effectiveness assessment was performed on three Risk Control Options (RCOs), taking into account potential differences between newbuildings and existing ships.

From a containment perspective, the RCO *Fire monitors on weather decks* was found cost-effective for newbuildings and existing ships of the three ship categories.

From an evacuation outlook, a safe distance was estimated to ensure the protection of stowage areas, embarkation stations and evacuation routes, and LSA failure due to heat and smoke following a fire in a ro-ro space. Several design solutions were investigated and cost-effective solutions were found for the Standard RoPax and Ferry RoPax.

2 EXECUTIVE SUMMARY

Fire and smoke containment are well known issues during fires in ro-ro spaces, especially in case of uncontrolled fires. Similarly, in some accidents, evacuation systems remained inoperative due to the heat and flames coming through the openings of the ro-ro spaces. New systems and proposals for containment and safe evacuation are investigated in this report. These aspects were not investigated in detail in the previous FIRESAFE study.

The main objective of FIRESAFE II was to improve the fire safety of ro-ro passenger ships by cost-efficient safety measures reducing the risk of ro-ro space fire, with an aim to discuss specific proposals for rule making. In Part 2 of the study, reported here, the objective was to identify a range of risk control options (RCOs) and assess the ones most likely to be cost efficient in relation to containment and evacuation due to a ro-ro space fire.

The study considered open ro-ro spaces, closed ro-ro spaces as well as weather decks, for both newbuildings and existing ships.

The Formal Safety Assessment (FSA) methodology was followed, as described in the Guidelines MSC-MEPC.2/Circ.12/Rev.2. The FSA is a structured and systematic methodology aimed at enhancing maritime safety and consists of the following five steps:

- Step 1: Hazard identification;
- Step 2: Risk analysis;
- Step 3: Risk control options;
- Step 4: Cost-effectiveness assessment; and
- Step 5: Recommendations for Decision-Making.

In order to perform this investigation in line with the FSA methodology, a review of regulations and current practices concerning fire containment and fire integrity of LSAs (and fire exposure criteria for humans) was also first conducted.

To consider the diverse world fleet of RoPax ships in the study, three generic categories of ships were defined based on a lane metre to passenger capacity ratio:

- *Ferry RoPax*, represent RoPax ships or ferries with focus on carriage of passengers but which can also carry cargo similar to a *Standard RoPax*. These ships typically only have closed ro-ro spaces or mainly closed ro-ro spaces and a small weather deck;
- *Standard RoPax*, represent the RoPax ships with focus on both carriage of cargo and of passengers. These vessels typically have each of the three types of ro-ro spaces: closed ro-ro spaces, open ro-ro spaces and weather decks. The size of the weather deck/s is generally medium to large within this category; and
- *Cargo RoPax*, represent RoPax ships with focus on carriage of cargo and basically have a passenger capacity just enough to carry the number of drivers necessary to load the ro-ro spaces with accompanied trailers. These vessels typically have closed ro-ro spaces and large weather deck/s.

Both hazards that have materialized in the past and those that have not been experienced (yet) were identified through analytical and creative techniques to produce a list of hazards relevant to containment failure and evacuation failure.

For the containment part, some notable results from the hazard identification were:

- Side openings were considered a major hazard for fire and smoke spread to Life Saving Appliances (LSAs), ventilation inlets, decks above, but also end openings pose a significant hazard;
- Openings provide oxygen to the fire;
- A major concern with ro-ro space fires is that the space is not sub-divided, meaning that an uncontrolled ro-ro space fire may involve the whole length of the ship. The fire will quickly grow intense and could last for a very long time (days);

- On general ro-ro cargo ships, fire insulation (A-30) is required between decks, but this is not required on RoPax ships (except every 10 meters in height). Without insulation, fire vertical spread after about 10 minutes is possible (without extinguishing system activated);
- Fire spread to weather deck, due to flame spread through openings or heat transfer through the deck, is difficult to avoid due to lack of fire integrity and limited possibilities for management (only manual efforts, limited equipment, accessibility problems, etc.). Fire spread to weather deck is associated with high risk since there are no fixed means for extinguishment and the accessibility for safe manual firefighting is limited, which gives a high probability of an uncontrolled fire;
- Smoke spread from the ro-ro space to the accommodation part of the ship is a major concern and it is difficult to achieve an over pressure in all spaces adjacent to a ro-ro space; and
- Doors to the ro-ro space are generally not smoke tight, since this is not tested in accordance with the Fire Test Procedure (FTP) Code.

For the evacuation part, some notable results from the hazard identification were:

- Side openings were considered a major hazard for fire and smoke spread to LSA, but also end openings pose a significant hazard;
- Smoke may spread from side openings and ventilation outlets and affect the possibilities for using LSA, escape routes, embarkation stations, etc.;
- A fire in ro-ro space may block the use of LSA by hindering embarkation or deployment, burning guiding ropes, etc.;
- Many critical cables run through the ro-ro space and fire deterioration may cause loss of power, navigation impossibility, black out, etc., regardless of the current provisions;
- Heat spread to escape routes and embarkation stations is critical, in particular if the use of LSA is hindered and since a ro-ro space fire can be very intense and long-lasting;
- It is seldom possible to provide of a secondary means of conventional disembarkation of the ship (not considering use of LSA) when berthing a foreign harbour (where gangways are not usable). Evacuation through the stern ramp may not be possible due to fire; and
- Passengers are generally not allowed in the ro-ro space before the ship is alongside, but if this occurs, fire in a ro-ro space full of passengers is a worst possible evacuation scenario.

The main fire risk model and the associated sub-models were developed in such a way that it is possible to assess, in quantitative values, the consequences of additional preventing and mitigating measures addressing the risks of containment and evacuation failures.

For containment, dedicated fault trees were developed for the different types of RoPax ships and ro-ro spaces, focusing on the main hazards identified during the HazId (Hazard Identification). The trees were quantified to gain an understanding of the impacts on risks and to investigate in further detail the important causes and initiating events of the accident scenarios identified. This allowed quantification of the contributing containment failures as well as to calculate the overall containment failure rate. In order to consider the different types of ro-ro spaces, different trees were developed and quantified by investigation of available failure data, fire simulations and expert judgement, in case none of the previous options were available.

A range of Risk Control Measures (RCMs) was identified based on the hazards identified in previous steps and on proposals of RCMs identified in former projects. All the measures presume an existing fire and are classified as mitigating, rather than preventive. The RCMs were ranked by experts with regard to risk reduction potential and estimated costs. Based on this ranking and on the high-risk areas needing control in the fault tree, the RCMs with the highest potential were judged to be:

- Ban/Closure of side and end openings;
- Requirement for fire insulation (at least) A-30 instead of A-0 between ro-ro decks;
- Implementation of new test and requirement for enhanced smoke-tight A-60 divisions for ro-ro space boundaries;
- Fire monitors on weather deck;
- Subdivision between ro-ro space without openings and space with openings;
- Closure of side openings on ro-ro spaces; and
- Increased fire insulation for ro-ro space boundaries, e.g. A-180 towards accommodation areas.

Two of the above RCMs were selected as Risk Control Options (RCOs) for further quantitative cost-effectiveness analysis, based on their perceived cost-effectiveness, Technology Readiness Level (TRL), and availability:

- Ban/closure of side & end openings: From a containment point of view, the main benefit of fewer openings is to avoid smoke and flames escaping from the fire enclosure, preventing propagation of the fire to spaces above the opening and harmful exposure to smoke. Both open and closed ro-ro spaces have openings that could be closed. Ro-ro spaces are defined as closed also if there is an opening at one end and side openings are less than 10% of the total area of the space sides. (SOLAS II-2/3.12). This risk control measure implies to forbid open ro-ro spaces on new ships and to reduce openings (including aft openings) in general as far as practicable; and
- Fixed fire-extinguishing systems (e.g. fire monitors) on weather deck: Weather deck is fairly unprotected both with regard to fire prevention (fire spread) and fire extinguishment. In case of a fire in the ro-ro space underneath, fire monitors could prevent flame spread through openings or heat spread through the un-insulated deck. In a case of a fire on weather deck, the use of fire monitors may extinguish or avoid propagation of the fire by reducing the amount of radiation from flames. This RCO implies that weather deck on ro-ro passenger ships shall be provided fixed fire protection arrangements (here fire monitors) for the purpose of containing a fire in the space/area of origin.

Regarding the failure of evacuation the main issue addressed was related to SOLAS Ch. II-2, Reg. 20.3.1.5: “Permanent openings in the side plating, the ends or deckhead of the space shall be so situated that a fire in the cargo space does not endanger stowage areas and embarkation stations for survival craft and accommodation spaces, service spaces and control stations in superstructures and deckhouses above the cargo spaces.” Based on simulations, the safe distance and arrangement of such openings were estimated. Although other means of failure of evacuation following a fire on a ro-ro deck were also identified, the focus of the study was that of protection of stowage areas, embarkation stations and LSA failure due to heat but not LSA failure due to intrinsic or environmental issues.

Several design solutions were investigated to achieve the RCO *Safe distance* on the *Standard RoPax* and *Ferry RoPax*, on which the LSAs were within the hazardous zone. Although the stowage areas, embarkation stations and LSAs were located outside of this zone on the *Cargo RoPax*, the closure of the aft opening was investigated to identify whether the safety level on this ship could be improved in a cost-effective manner.

The estimated risk reduction effect of the above RCOs were quantified by investigation of available failure data, fire simulations and expert judgement, in case none of the previous options were available. By applying each of the risk control options to the risk model (event tree), the risk reduction of all selected RCOs was calculated.

Costs for the implementation of these RCOs were estimated. Technical items available on the market were as far as possible quantified by system supplier offers. In addition, cost estimations were based on existing costs for material from ship operator’s internal projects, specifications, reconstructions, etc. The main component systems of each RCO were identified and respective costs were estimated. Other cost items affecting for example operations were included in the quantification when necessary.

The cost-effectiveness criteria were updated. A RCO was considered cost-effective if the Gross Cost of Averting a Fatality (GCAF) is below €7 M. A RCO was also considered cost effective if the Net Cost of Averting a Fatality (NCAF), accounting for the economic benefits of the RCO, is below €7 M.

The findings of the cost-effectiveness assessment is summarised in the below table.

	RCO	Newbuildings			Existing Ships		
		Cargo RoPax	Standard RoPax	Ferry RoPax	Cargo RoPax	Standard RoPax	Ferry RoPax
Containment	Ban/closure of side & end openings (closed and open ro-ro spaces)	Not cost-effective	Not cost-effective	Not cost-effective	Not cost-effective	Not cost-effective	Not cost-effective
	Fire monitors on weather deck	Cost-effective	Cost-effective	Cost-effective	Cost-effective	Cost-effective	Cost-effective
Evacuation	Safe Distance	Not applicable	Cost-effective	Cost-effective	Not applicable	Cost-effective	Not cost-effective

The FSA demonstrated that the following RCOs achieved the highest risk reduction in a cost-effective manner (ranked from highest to lowest risk reduction):

- For Newbuildings:
 - Regardless of the ship category:
 - Fire monitors on weather deck; and
 - Safe distance
- For Existing ships:
 - Regardless of the ship category:
 - Fire monitors on weather deck.
 - For Standard RoPax
 - Safe distance

It should also be noted that the relative risk reductions of the RCOs only take into account the effects of the RCOs on the respective Containment and Evacuation nodes in the main fire risk model. However, any effects that the RCOs could have directly on the other main branches of the main fire risk model event tree were disregarded which may render cost-effective some RCO that were not in this part (no negative side effects expected). These considerations were taken into account in the Combined Assessment part of the FIRESAFE II study (EMSA, 2018).

Finally, recommendations on how the cost-effective RCOs could be implemented were discussed.

3 CONTENTS

1	ABSTRACT	3
2	EXECUTIVE SUMMARY	4
3	CONTENTS	8
4	TABLE OF FIGURES	11
5	TABLE OF TABLES	13
6	INTRODUCTION	16
6.1	Scope and objectives	16
6.2	Background	16
6.3	Methodology	16
7	BACKGROUND INFORMATION	18
7.1	Analysis of the RoPax fleet	18
7.2	Overview of relevant regulations and requirements – General	18
7.3	Overview of relevant regulations and requirements – Requirements	22
7.4	Fire resistance of LSAs	25
7.5	Generic ships	26
8	HAZARD IDENTIFICATION	36
8.1	Hazard Identification – Containment	36
8.2	Hazard Identification – Evacuation	38
9	RISK ANALYSIS	40
9.1	Background	40
9.2	Main fire risk model	40
9.3	Containment Fault tree	44
9.4	Evacuation / Fire integrity of LSAs risk model	61
9.5	Risk quantification	85

10	RISK CONTROL OPTIONS - CONTAINMENT	87
10.1	Identification of RCOs	87
10.2	Detailed description of relevant RCOs	88
10.3	Selected RCOs	91
10.4	Technical specifications of RCOs	91
10.5	Quantification of RCO effectiveness	92
10.6	Estimation of Risk Reduction by the implementation of RCOs	98
11	RISK CONTROL OPTIONS – EVACUATION	101
11.1	Identification of RCOs	101
11.2	Detailed description of RCO applied to generic ships	101
11.3	Selected measures	104
11.4	Technical Specifications of measures	104
11.5	Quantification of evacuation RCO effectiveness	106
11.6	Estimation of Risk Reduction by the implementation of the RCO	107
12	COST-EFFECTIVENESS ASSESSMENT	109
12.1	Cost-effectiveness assessment – background	109
12.2	Estimation of costs	109
12.3	GCAF / NCAF ratio and RCOs ranking	124
12.4	Results of the sensitivity and uncertainty analyses	126
12.5	Objective comparison of alternative options	127
13	RECOMMENDATION FOR DECISION-MAKING	129
13.1	Recommendation for decision-making	129
13.2	Discussion on how recommendations could be implemented by decision-makers	131
14	CONCLUSION	135
15	BIBLIOGRAPHY	138

A1	ANNEXES:	140
A1.1	Data from fire containment HazId	140
A1.2	Data from evacuation fire HazId	147
A1.3	Updated Main fire risk model (<i>Cargo RoPax</i> – Newbuildings)	154
A1.4	Updated Main fire risk model (<i>Standard RoPax</i> – Newbuildings)	156
A1.5	Updated Main fire risk model (<i>Ferry RoPax</i> – Newbuildings)	159
A1.6	Quantification of the Containment fault trees	161
A1.7	Risk control measures – Containment	171
A1.8	Ranking matrix – Containment (Newbuildings)	176
A1.9	Ranking matrix – Containment (Existing ships)	177
A1.10	Participants of the fire containment hazard identification workshop and their expertise	178
A1.11	Participants of the fire evacuation hazard identification workshop and their expertise	179

A2	LIST OF ABBREVIATIONS	180
-----------	------------------------------	------------

4 TABLE OF FIGURES

Figure 1: Regulation mapping for fire containment failure in the ro-ro spaces of passenger ships	19
Figure 2: Regulation mapping for evacuation failure in the ro-ro spaces of passenger ships	20
Figure 3: Lane meter to passenger ratio categorized according to the FIRESAFE II Group on the Stena fleet	28
Figure 4: Lane meter capacity vs. number of passengers for the FIRESAFE II fleet (in black) and the Stena fleet (in colour) and FIRESAFE II groups (red lines)	29
Figure 5: Picture of the Stena Gothica (<i>Cargo RoPax</i> ship)	30
Figure 6: Picture of the Stena Flavia (<i>Standard RoPax</i> ship)	32
Figure 7: Picture of the Stena Superfast VIII (<i>Ferry RoPax</i> ship)	34
Figure 8: Updated chain of events for FIRESAFE II.....	41
Figure 9: Updated Main Fire Risk Model for the <i>Standard RoPax Newbuilding</i> (<i>Open ro-ro spaces</i> part)..	42
Figure 10: Containment fault tree for closed and open ro-ro spaces	44
Figure 11: Sub-tree for failure of fire containment for closed and open ro-ro spaces.....	46
Figure 12: Containment fault tree for weather deck on <i>Standard RoPax</i> Newbuilding.....	47
Figure 13: Sub-tree for failure of smoke containment for closed and open ro-ro spaces.	48
Figure 14: Distributions of the probability of Containment failure on Closed ro-ro spaces, Open ro-ro spaces and Weather decks of the <i>Standard RoPax</i> Newbuildings, according to the outcome of Extinguishment node,	50
Figure 15: Scientific representation of a fire on a weather deck and its radiant heat exposure on LSAs....	63
Figure 16: Incident radiant heat flux as a function of the distance flame-LSA for the case of the <i>Ferry RoPax</i>	65
Figure 17: View of the ro-ro space used for the simulations.	66
Figure 18: Position of the radiant heat flux sensors close to openings.	67
Figure 19: Maximal incident radiant heat fluxes received by FDS sensors for the worst-case scenario	68
Figure 20: Minimal distance based on radiative heat flux criteria of 5.0 and 2.5 kW/m ²	69
Figure 21: Zones in which LSAs should be excluded, where exclusion zone type 1 (red) applies to LSAs which may involve passengers and exclusion zone type 2 (blue) applies to LSAs which do not involve passengers (e.g. life rafts launched directly into the water).	70
Figure 22: Illustration of the smoke plume from an opening	71
Figure 23: Starboard arrangement of openings for the <i>Standard RoPax</i> ship.....	73
Figure 24: Openings of the <i>Standard RoPax</i> on deck 4, from above.....	73
Figure 25: Picture illustrating a part of the aft opening on the <i>Standard RoPax</i> selected.	73
Figure 26 Principle for measuring the distances between openings and LSAs.	74
Figure 27: Starboard side and top view of the <i>Cargo RoPax</i> ship with marked openings and LSAs.	76
Figure 28: Picture of the aft opening of the <i>Cargo RoPax</i>	76
Figure 29: Top view of the bridge deck of the <i>Cargo RoPax</i>	76
Figure 30 Starboard side and top view of the <i>Ferry RoPax</i> with marked openings and LSAs.	77
Figure 31: Picture of the aft openings on the <i>Ferry RoPax</i> ship.	78

Figure 32: Evacuation model used to estimate the probability of evacuation failure in case of containment failure (Vanem & Skjong, 2004).....	79
Figure 33: Zoning of open ro-ro space, where the colouring illustrates the different zones (red zone=critical, yellow=partially critical).....	82
Figure 34: The Standard RoPax has two weather decks, one located in the far aft, and one located in the middle of the ship. Only fire on the latter one was deemed to cause evacuation failure given that the wind blows towards LSAs.....	83
Figure 35: Potential Loss of Life (PLL) for the three generic ships considered.....	85
Figure 36: Potential Loss of Cargo (PLC) and Potential Loss of Ship (PLS) for the three generic ships considered.....	86
Figure 37: Relative Risk Reduction of Containment RCOs for Newbuildings.....	99
Figure 38: Relative Risk Reduction of Containment RCOs for Existing Ships.....	99
Figure 39: Relative Risk Reduction of the three designs investigated for the RCO <i>Safe distance</i> for Newbuildings.....	107
Figure 40: Relative Risk Reduction of the three designs investigated for the RCO <i>Safe distance</i> for Existing Ships.....	107
Figure 41: <i>Cargo RoPax</i> from the aft. Slight adjustments to the opening and the roll will be located just above the opening.....	110
Figure 42: Left picture: <i>Cargo RoPax</i> bigger openings port side that needs to be closed. Right picture: starboard side at the same location.....	110
Figure 43: Picture showing <i>Standard RoPax</i> opening port side from the aft. It is worth noting the ramp down to deck 3.....	112
Figure 44: Picture showing <i>Standard RoPax</i> opening starboard side from the aft.....	113
Figure 45: Picture showing <i>Standard RoPax</i> sister vessel openings from the aft.....	113
Figure 46: Above figure showing <i>Ferry RoPax</i> from aft. Roller shutter will be fitted at frame 36.....	114
Figure 47: View from above. Roller shutter will be fitted at frame 36. Red is plate insert and blue is plate.....	115
Figure 48: <i>Cargo RoPax</i> – Fire monitors localisation and coverages.....	118
Figure 49: <i>Standard RoPax</i> – Fire monitors localisation and coverages.....	118
Figure 50: <i>Ferry RoPax</i> – Fire monitors localisation and coverages.....	118

5 TABLE OF TABLES

Table 1: List of documents used for the review of regulations	21
Table 2: Personal live-saving appliances and their fire requirements.....	25
Table 3: Survival craft and their fire requirements.....	25
Table 4: Typical description of the main groups.....	27
Table 5: Main characteristics of the <i>Cargo RoPax</i> ship	30
Table 6: Description of the cargo decks of the <i>Cargo RoPax</i> ship.....	31
Table 7: Main characteristics of the <i>Standard RoPax</i> ship	32
Table 8: Description of the cargo decks of the <i>Standard RoPax</i> ship.....	33
Table 9: Main characteristics of the <i>Ferry RoPax</i> ship.....	34
Table 10: Description of the cargo decks of the <i>Ferry RoPax</i> ship.....	35
Table 11: Probabilities of containment failure due to smoke or fire containment failure for <i>Standard RoPax</i> Newbuildings. 90% confidence interval is indicated in square brackets.	49
Table 12: Probabilities of fire containment failures due to flame or heat spread for <i>Standard RoPax</i> Newbuildings	51
Table 13: Probabilities for flame spread through openings for <i>Standard RoPax</i> Newbuildings	52
Table 14: Probabilities for heat spread for <i>Standard RoPax</i> Newbuildings	53
Table 15: Probabilities of failures causing heat spread due to insulation failure for closed ro-ro spaces on <i>Standard RoPax</i> Newbuildings	53
Table 16: Probabilities of failures causing smoke containment failure for the case of the <i>Standard RoPax</i> Newbuildings	54
Table 17: Probabilities of failures causing external smoke containment failure for <i>Standard RoPax</i> Newbuildings	55
Table 18: Probabilities of Door failures causing weaknesses in division smoke tightness and thus internal smoke spread failure for closed ro-ro spaces on <i>Standard RoPax</i> Newbuildings	56
Table 19: Probabilities of deck or bulkhead failures causing weaknesses in division smoke tightness and thus internal smoke spread for <i>Standard RoPax</i> Newbuildings	57
Table 20: Differences in containment failure probabilities (bottom nodes) for closed ro-ro spaces depending on ship type (relative to <i>Standard RoPax</i>).....	58
Table 21: Differences in containment failure probabilities (bottom nodes) for weather deck spaces depending on ship type (relative to <i>Standard RoPax</i>).....	60
Table 22: Group of materials used in LSAs and their critical heat flux, from (SFPE, 2002)	62
Table 23: Radiant heat flux safety criteria for LSAs	62
Table 24: Thermo-physical data used as input for the solid flame model (Arvidson, 1997)	65
Table 25: Safety distances for LSA on the top deck of the <i>Standard RoPax</i> ship.....	66
Table 26: Input values used in the fire scenarios simulated to evaluate radiative heat flux through ro-ro space side openings.....	67
Table 27: Maximal variation of plume radius depending on RoPax ship type	71
Table 28: Required safety distances from ro-ro space side openings to LSAs	72
Table 29: Measured distances between openings and LSAs on the <i>Standard RoPax</i> ship.....	75

Table 30: Measured distances between openings and LSAs on the <i>Cargo RoPax</i>	77
Table 31: Measured distances between openings and LSAs on the <i>Ferry RoPax</i> ship.	78
Table 32: Top-ranked RCMs to avoid containment failure	87
Table 33: Reduction of failure probability for containment nodes impacted by considered RCO for <i>Standard RoPax</i>	94
Table 34: Reduction of failure probability for containment nodes impacted by considered RCO for <i>Cargo RoPax</i>	94
Table 35: Reduction of failure probability for containment nodes impacted by considered RCO for <i>Ferry RoPax</i>	95
Table 36: Reduction of failure probability for containment nodes impacted by considered RCO for <i>Standard RoPax</i>	97
Table 37: Reduction of failure probability for containment nodes impacted by considered RCO for <i>Cargo RoPax</i>	98
Table 38: Reduction of failure probability for containment nodes impacted by considered RCO for <i>Ferry RoPax</i>	98
Table 39: Variations of evacuation RCO relevant for the different generic RoPax ships.....	102
Table 40: Details of the costs for the implementation of the RCO <i>Ban/Closure of side & end openings</i> on Existing ships	116
Table 41: Lifetime marginal cost (in present value) for the implementation of the RCO <i>Ban/Closure of side & end openings</i> on Existing ships	116
Table 42: Details of the costs for the implementation of the RCO <i>Ban/Closure of side & end openings</i> on Newbuildings	117
Table 43: Lifetime marginal cost (in present value) for the implementation of the RCO <i>Ban/Closure of side & end openings</i> on Newbuildings.....	117
Table 44: Details of the costs for the implementation of the RCO <i>Fire monitors on weather deck</i> on Existing ships.....	119
Table 45: Lifetime marginal cost (in present value) for the implementation of the RCO <i>Fire monitor on weather deck</i> on Existing ships	119
Table 46: Lifetime marginal cost (in present value) for the implementation of the <i>RCO Fire monitor on weather deck</i> on newbuildings	119
Table 47: Details of the costs for the implementation of the measure - <i>Closing all significant openings on Existing ships</i>	120
Table 48: Details of the costs for the implementation of the measure - <i>Closing all side openings on Existing ships</i>	121
Table 49: Details of the costs for the implementation of the measure - Closing side openings near LSAs on Existing ships	121
Table 50: Lifetime marginal cost (in present value) for the implementation of the three measures investigated within the RCO <i>Safe distance</i> on existing ships	121
Table 51: Details of the costs for the implementation of the measure - Closing all significant openings on newbuildings	122
Table 52: Details of the costs for the implementation of the measure - Closing all side openings on newbuildings	122

Table 53: Details of the costs for the implementation of the measure - Closing side openings near LSAs on newbuildings	122
Table 54: Lifetime marginal cost (in present value) for the implementation of the three measures investigated within the RCO <i>Safe distance</i> on existing ships	123
Table 55: Δ Risk, Δ Costs, GCAF and GCAF Factor values for the Containment RCOs on Newbuildings	124
Table 56: Δ Risk, Δ Costs, Δ Benefits, NCAF and NCAF Factor values for the Containment RCOs on Newbuildings	125
Table 57: Δ Risk, Δ Costs, GCAF and GCAF Factor values for the Containment RCOs on Existing ships	125
Table 58: Δ Risk, Δ Costs, Δ Benefits, NCAF and NCAF Factor values for the Containment RCOs on Existing ships.....	125
Table 59: Δ Risk, Δ Costs, GCAF and GCAF Factor values for the different designs investigated for the Evacuation RCO on Newbuildings	126
Table 60: Δ Risk, Δ Costs, GCAF and GCAF Factor values for the different designs investigated for the Evacuation RCO on Existing ships.....	126
Table 61: Confidence (conf) of Containment and Evacuation RCOs having GCAF<1 based on uncertainty analysis.....	127
Table 62: GCAF Factors for the different containment RCOs on each generic vessel (for both Newbuildings and Existing ships).....	127
Table 63: Relative risk reduction for the different containment RCOs on each generic vessel (for both Newbuildings and Existing ships)	127
Table 64: GCAF Factor for the evacuation RCO on each generic vessel (for both Newbuildings and Existing ships)	128
Table 65: Relative risk reduction for the Evacuation RCO on each generic vessel (for both Newbuildings and Existing ships).....	128

6 INTRODUCTION

6.1 Scope and objectives

The main objective of FIRESAFE II was to improve the fire safety of ro-ro passenger ships by cost-efficient safety measures reducing the risk of ro-ro space fire, with an aim to discuss specific proposals for rule making. In Part 2 of the study, reported here, the objective was to identify a range of risk control options (RCOs) and assess the ones most likely to be cost efficient in relation to containment and evacuation due to a ro-ro space fire, considering open ro-ro spaces, closed ro-ro spaces as well as weather decks, for both Newbuildings and Existing ships.

6.2 Background

In 2016, EMSA initiated the FIRESAFE study in order to investigate cost-efficient measures for reducing the risk from fires on ro-ro passenger ships with a focus on Electrical Fire as ignition source as well as Fire Extinguishing Failure. These areas were considered the greatest risk contributors by the EMSA Group of Experts on fires on ro-ro decks.

The study produced a coarse risk model covering the various stages of a fire incident on a ro-ro passenger ship, namely: ignition, detection/decision, extinguishment, containment and evacuation.

In 2017, EMSA initiated the FIRESAFE II study to investigate Risk Control Options (RCOs) for mitigating the risk from fires in ro-ro spaces in relation to Detection and Decision (Part 1) as well as Containment and Evacuation (Part 2), which are items which were not addressed specifically in FIRESAFE.

Two additional parts, one focusing on alternative fixed fire-extinguishing systems for ro-ro decks (Part 3), and one part focusing on detection systems in open ro-ro spaces and weather decks (Part 4) were also included.

Fire and smoke containment are well known issues during fires on ro-ro spaces, especially for the case of uncontrolled fires. Similarly, in some accidents, evacuation systems remained inoperative due to the heat and flames coming through the side openings of the ro-ro spaces.

In this new study, the nodes *containment failure* and *evacuation (or fire integrity of evacuation routes and LSAs) failure* were analytically investigated.

6.3 Methodology

In order to achieve the objectives described in section 6.1, the Formal Safety Assessment methodology was followed.

A summary of the steps detailed in the “Revised Guidelines for Formal Safety Assessment (FSA) for Use in the IMO Rule-Making Process” (IMO, 2018) is provided below:

- Problem Definition: The objective of this step is to clarify the objectives and clearly define the scope of the study. This was done through an analysis of the RoPax fleet, of relevant regulations, requirements and current practices related to containment and evacuation. In particular, the problem definition leads to the development of generic ships. The details of this task are described in Chapter 7;
- 1st step: Identification of Hazards: The purpose of this step is to identify relevant hazards to the safety matter under consideration. Both hazards that have materialized in the past and those that have not been experienced (yet) were identified through analytical and creative techniques. The details of this step are described in Chapter 8;
- 2nd step: Risk Analysis: The purpose of this step is to investigate in further detail the causes and initiating events of the accident scenarios identified in the 1st step. A main fire risk model and dedicated fault trees were developed and quantified for this purpose and are detailed in Chapter 9;
- 3rd step: Risk Control Options: The purpose of this step is to identify Risk Control Measures and propose potential Risk Control Options for reducing the risk. Relevant risk control options are

selected and their technical specifications and risk reduction potential are further described. The details of this step are described in Chapters 10 and 11;

- 4th step: Cost-effectiveness assessment: In this step, the RCOs selected in Chapter 10 are analyzed in a way to facilitate the understanding of the costs and benefits resulting from the potential adoption of such RCOs. This results in a ranking of the RCOs from a cost-efficiency perspective. The results of this step are provided in Chapter 12; and
- 5th step: Recommendations for Decision-Making. Based on the above tasks, and in particular the cost-effectiveness assessment, specific proposals for rule making are discussed. These discussions are presented in Chapter 13.

7 BACKGROUND INFORMATION

7.1 Analysis of the RoPax fleet

All information necessary to the completion of the FSA study were extensively detailed in the report for Part 1 (detection and decision) of the FIRESAFE II study (EMSA, 2018). Only a summary of the results and details related to containment and evacuation are provided below.

7.1.1 FIRESAFE II Fleet: Selection criteria & analysis

The fleet under consideration was restricted to vessels:

- classed as Passenger/Ro-Ro Ship;
- engaged on international voyages or EU domestic class A;
- gross tonnage equal or greater than 1,000;
- with a build date on or after 01/01/1970;
- Froude number less than 0.5¹; and
- Classed or having been classed by one of the IACS members.

The FIRESAFE II fleet is composed of 811 ships active during the period 2002-2016 leading to a total of 7001 shipyears over the period 2002 – 2016 (very slight increase over the years).

The average age of the fleet is 20 years old in 2016, with an average loss age of 32 years old, (and maximum age of 46 years old). The life expectancy (at delivery) over the period 2002-2016 was estimated to 39.2 years old.

The average gross tonnage of the fleet over the period 2002-2016 is 21 120 GT (slight increase between 2002 and 2012 followed by a slight decrease until 2016).

7.2 Overview of relevant regulations and requirements – General

7.2.1 Introduction

7.2.1.1 Scope

This section aims at giving an overview of containment and evacuation requirements applicable in ro-ro spaces of passenger ships, with a specific focus on weather decks and open ro-ro spaces.

The general principle is summarized in SOLAS II-2/20.2.2: Horizontal zones extending over the full length of the ro-ro spaces are defined in order to locally replace the usual concept of Main Vertical Zones (MVZ) without need to split the ro-ro space into 40 m long zones. This governs the protection towards open and closed ro-ro spaces.

However, it is to be kept in mind that there are almost no provisions for protection towards weather decks used as ro-ro spaces.

7.2.1.2 Applicable regulations

It is to be noted that the present review is based on the currently applicable regulations. However, it can be noted that:

- The general principles for fire containment and evacuation on ro-ro passenger ships have been set in SOLAS 74, which is applicable to ships built after 1980. These safety measures have actually been introduced in SOLAS 60 part H as per IMO resolution A.122(V) dated October 1967. However, the circular was never made mandatory and Part H was therefore only applied on a voluntary basis until SOLAS 74 came into force. Compliance with Part H is formally recognized to be equivalent with SOLAS 74.

¹ To exclude High Speed Crafts.

- Only limited changes in these Rules have been introduced over the past 40 years

As a general remark, there are very little specific requirements related to containment and evacuation with respect to ro-ro spaces in Classification and Flag Rules. This topic is mainly covered by IMO Regulations. Therefore, this section is mainly based on SOLAS II-2/9, 13 and 20.

7.2.1.3 Regulation mapping

Specific attention was given to the “failure of fire containment” branch and “failure in evacuation” branch of the schematic trees proposed by the EMSA Group of Experts on fires on ro-ro decks, resulting in the regulation mapping detailed below. At the end of each branch, reference is made to the relevant paragraphs of 7.3 of this document, where the content of the relevant regulation is summarized.

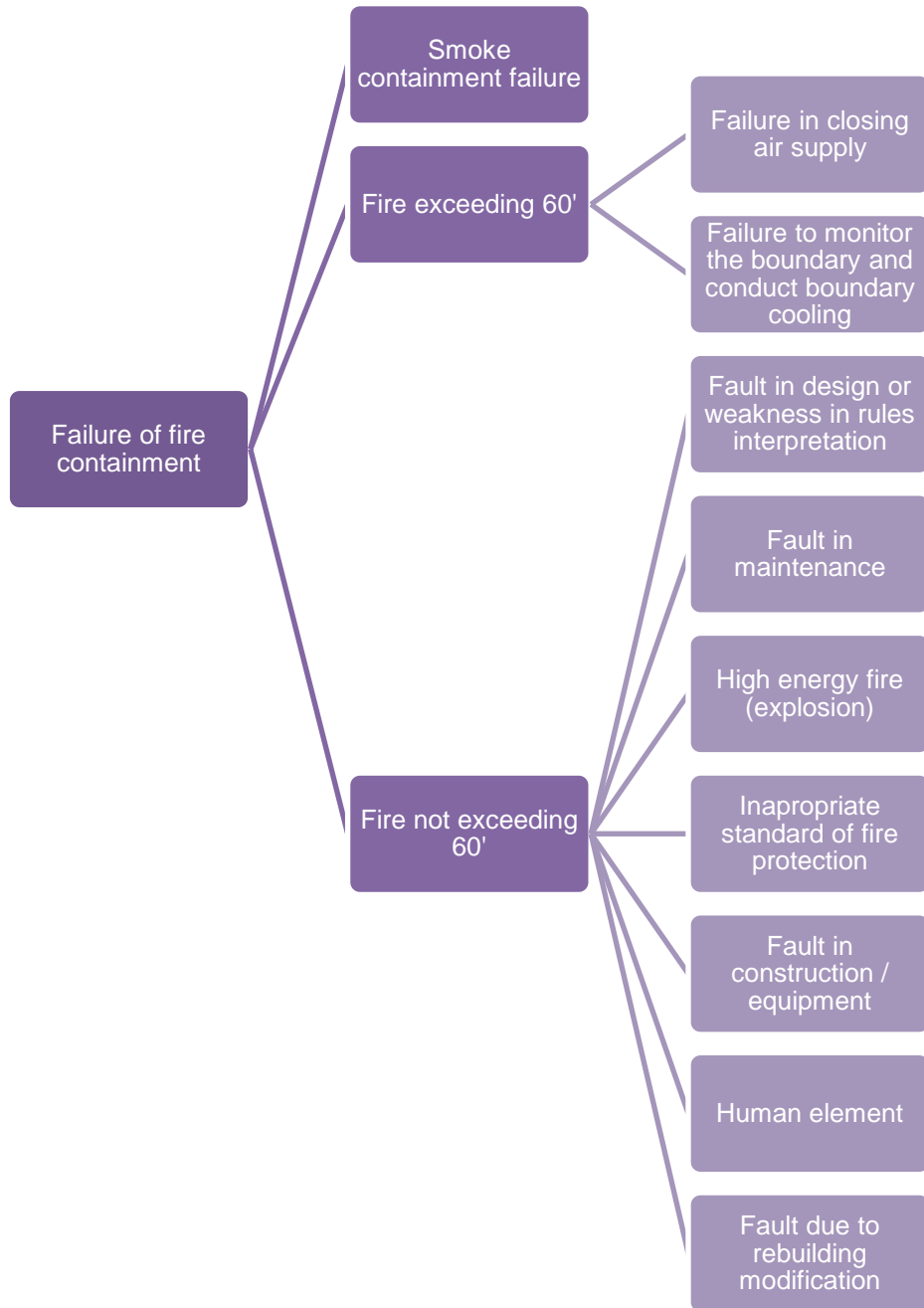

Figure 1: Regulation mapping for fire containment failure in the ro-ro spaces of passenger ships

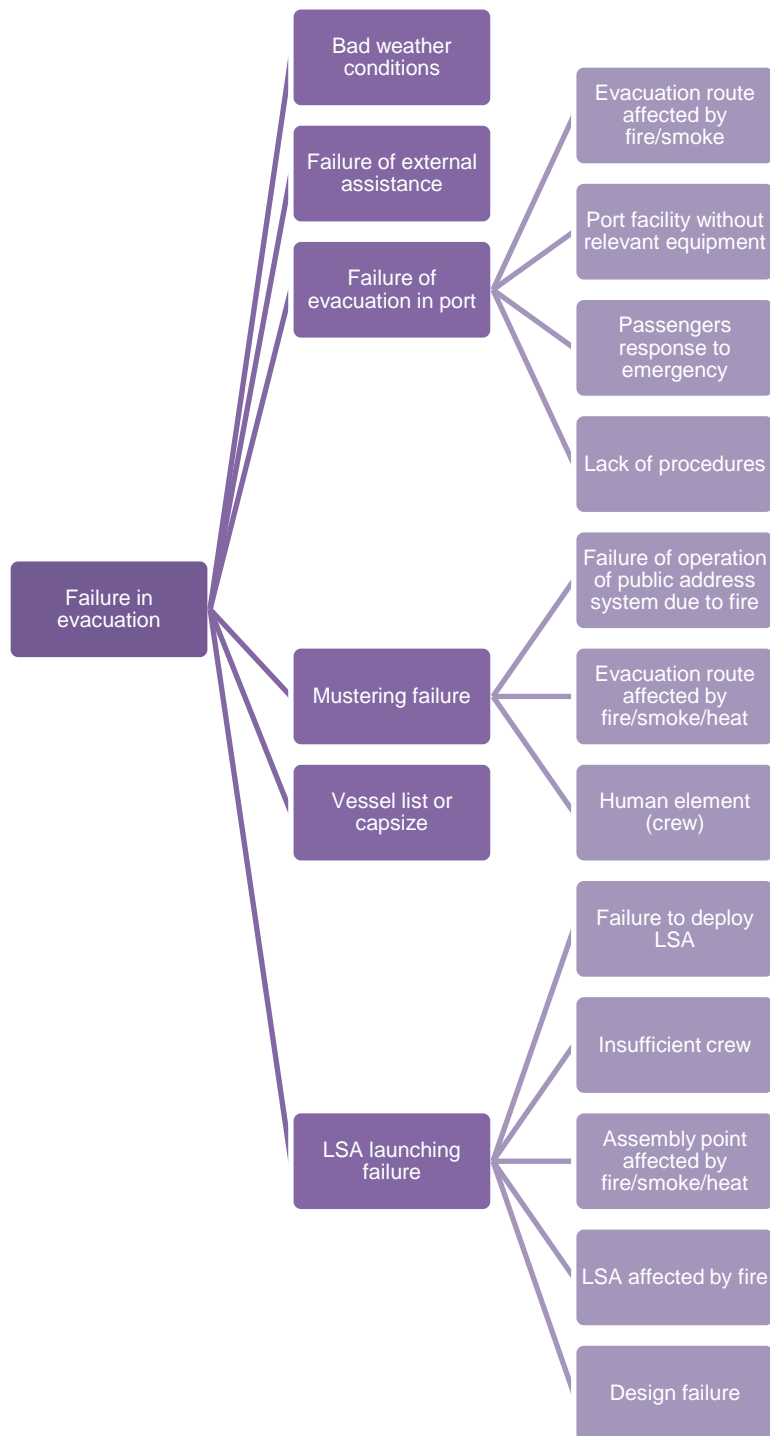

Figure 2: Regulation mapping for evacuation failure in the ro-ro spaces of passenger ships

7.2.2 Reference documents

The review was mainly based on the IMO and IACS documents listed in Table 1.

Table 1: List of documents used for the review of regulations

IMO Documents	Safety of Life at Sea (SOLAS) Convention, as amended in 2017
	Fire Test Procedure (FTP) Code, as amended in 2017
IACS Documents	UI SC86
	UI SC158 – Horizontal Fire Zone Concept
Classification Rules	BV Rules for Steel Ship (NR467), as amended in January 2018
	BV NR598 “Implementation of Safe Return to Port and Orderly Evacuation” dd. January 2016

7.2.3 Definitions

7.2.3.1 Ro-ro space, vehicle space and special category space

As per SOLAS II-2/3:

- “Vehicle spaces are cargo spaces intended for carriage of motor vehicles with fuel in their tanks for their own propulsion.”
- “Ro-ro spaces are spaces not normally subdivided in any way and normally extending to either a substantial length or the entire length of the ship in which motor vehicles with fuel in their tanks for their own propulsion and/or goods (packaged or in bulk, in or on rail or road cars, vehicles (including road or rail tankers), trailers, containers, pallets, demountable tanks or in or on similar stowage units or other receptacles) can be loaded and unloaded normally in a horizontal direction.”
- “Special category spaces are those enclosed vehicle spaces above and below the bulkhead deck, into and from which vehicles can be driven and to which passengers have access. Special category spaces may be accommodated on more than one deck provided that the total overall clear height for vehicles does not exceed 10 m.”
- Special category spaces are ro-ro spaces to which passengers have access, possibly during the voyage. Special category spaces are the most frequent type of closed ro-ro spaces on ro-ro passenger ships.
- It is to be noted that open ro-ro spaces are not considered as special category spaces.

7.2.3.2 Closed, open and weather deck

As per SOLAS II-2/3:

- A “weather deck is a deck which is completely exposed to the weather from above and from at least two sides.”
- IACS UI SC 86 additionally details that: “For the purposes of Reg. II-2/19 a ro-ro space fully open above and with full openings in both ends may be treated as a weather deck.”
- For practical purposes, drencher fire-extinguishing system cannot be fitted on weather decks due to the absence of deckhead. This criterion is often used for a practical definition of weather decks.
- An open vehicle or ro-ro space is “either open at both ends or [has] an opening at one end and [is] provided with adequate natural ventilation effective over [its] entire length through permanent openings distributed in the side plating or deckhead or from above, having a total area of at least 10% of the total area of the space sides.”
- A closed vehicle or ro-ro space is any vehicle or ro-ro space which is neither open nor a weather deck.
- As a reference criterion, it can be considered that a vehicle space that needs mechanical ventilation is a closed vehicle space.

7.3 Overview of relevant regulations and requirements – Requirements

7.3.1 Containment of fire

7.3.1.1 Horizontal zone concept

Ro-ro spaces are included in dedicated horizontal zones as allowed by SOLAS II-2/20.2.2.1. A horizontal zone may:

- Extend on the whole length of the ship;
- Include ro-ro spaces on more than one deck provided the total clear height does not exceed 10m

The concept of the horizontal zone is similar to that of a MVZ, i.e.:

- Most safety systems are to be segregated / provided with section that do not cover more than one MVZ or horizontal zone
- Specific attention is paid to the fire integrity of the boundaries of the horizontal zone or MVZ, as detailed below

7.3.1.2 Fire insulation

As a general rule, the boundaries of the ro-ro spaces would coincide with those of the horizontal fire zone, except that small spaces directly related to the ro-ro space (e.g. ventilation room for the ventilation of the ro-ro space) may be adjacent to the ro-ro space and included in the horizontal fire zone.

As per SOLAS II-2/9.2.2.1, horizontal zone boundaries are to have:

- A-60 fire integrity on passenger ships carrying more than 36 passengers (A-0 is acceptable when the adjacent/below/above space is an open deck, sanitary spaces, voids, water tanks, machinery spaces with little or no fire risk)
- A-class integrity on passenger ships carrying not more than 36 passengers

As per SOLAS II-2/20.5 and SOLAS II-2/9.2.2.4, the boundaries of ro-ro spaces and special category spaces are to have:

- A-60 fire integrity on passenger ships carrying more than 36 passengers (A-0 is acceptable when the adjacent/below/above space is an open deck, sanitary spaces, voids, water tanks, machinery spaces with little or no fire risk, or when the space below is a fuel oil tank²)
- A-30 fire integrity on passenger ships carrying not more than 36 passengers (A-60 is required with respect to spaces with very high fire risk, A-0 is accepted with respect to spaces with low fire risk, the detail can be found in tables 9.3 and 9.4 of SOLAS II-2/9)

In general, it is to be noted that these insulation requirements are well adapted for closed ro-ro spaces. For open ro-ro spaces, they are completed by the general principle stated in SOLAS II-2/20.3.1.5:

“Permanent openings in the side plating, the ends or deckhead of the [ro-ro] space shall be so situated that a fire in the cargo space does not endanger [...] accommodation spaces, service spaces and control stations in superstructures and deckhouses above the cargo spaces”

For the record, it is reminded that “A-30 or A-60” fire integrity means:

- Insulated decks and bulkheads are qualified to withstand the tests specified in IMO FTP Code (30 min exposure for A-30, 60 min exposure for A-60)
- Insulation usually needs to be extended on details, recesses, specific shapes etc.
- Pipe and duct penetrations are also to be qualified by relevant fire tests
- Installation on board is to be in line with the tested arrangement

² This is needed for practical purposes: It is indeed not relevant to install fire insulation in a fuel oil tank, as the insulation would get impregnated with fuel and quickly useless. It is not practicable either to install fire insulation on deck in ro-ro spaces.

7.3.1.3 Door requirements

Doors in ro-ro spaces boundaries are to have the same fire integrity as the bulkhead they are fitted in, provided with permanently attached means of closing (SOLAS II-2/9.4.1.1.1) and it is to be possible for one person to open and close the door from each side of the bulkhead (SOLAS II-2/9.4.1.1.3).

SOLAS II-2/9.6 requires a position indicator (open/closed) at the navigation bridge for each door in special category spaces boundaries.

In addition, doors in ro-ro spaces boundaries usually also belong to horizontal zone boundaries. In this respect, according to SOLAS II-2/9.4.1.1.4, they are required to:

- Be self-closing
- Be capable of local control and remote release. It is to be noted that local hold-back devices that cannot be remotely released are not allowed
- Be provided with an alarm, which is to sound in case the door is open
- Be provided with hose ports (for doors located on escape ways)

7.3.1.4 Ventilation system

In general, the ventilation system for ro-ro spaces is to be dedicated to the ro-ro space and is not to serve any other space as per SOLAS II-2/9.7.2.1.

As per SOLAS II-2/9.7.2.2, ventilation ducts serving a ro-ro space and crossing accommodation spaces, service spaces or control stations are required to:

- Be made of steel with reinforced thickness
- Be either provided with an automatic fire damper + A-60 insulation on 5 m beyond the damper or A-60 insulated throughout the accommodation, service spaces or control stations

The same applies to ventilation ducts serving accommodation spaces, service spaces or control stations if they pass through ro-ro spaces as per SOLAS II-2/9.7.2.3.

7.3.2 Evacuation

7.3.2.1 General philosophy

A number of precautions are taken in order to prevent a fire in the ro-ro spaces from jeopardizing escape from other spaces and ship evacuation.

As a general rule, vertical escape ways are categorized as “stairways” (category (2) on passenger ships carrying more than 36 passengers and category (4) on passenger ships carrying not more than 36 passengers), which ensures that they are suitably insulated with respect to ro-ro spaces.

In addition, on passenger ships carrying more than 36 passengers, a specific category (category (4)) is defined to cover “Evacuation stations and external escape routes”, so that A-60 insulation is required between ro-ro spaces and muster stations; lifeboat/liferaft stowage areas as well as their lowering paths.

7.3.2.2 Protection of escape ways

SOLAS includes provisions that protect the means of escape from spaces below the ro-ro spaces from being cut off by a fire in the ro-ro spaces:

- Accommodation spaces, service spaces and control stations are to be provided with two means of escape, one of which is to be an enclosed stairway providing continuous fire shelter up to the embarkation deck. Access from the stairway to the embarkation areas is to be insulated as a stairway, as per SOLAS II-2/13.3.2.
- Machinery spaces are to be provided with two means of escape. In addition, SOLAS II-2/13.5.2 makes it clear that, for machinery spaces where crew is normally employed, one of the escape routes is not to pass through ro-ro spaces.

In addition, SOLAS II-2/13.7 includes a number of provisions aiming at making the escape routes on ro-ro passenger ships as easy and direct as possible, with a view to quicken evacuation if needed, especially:

- Minimum number of changes in direction along a direction
- There should be no need to cross from one side of the ship to the other during escape
- Passengers should not need to climb more than 2 decks up or down to reach an assembly station
- External escape routes are required from open decks

7.3.2.3 Protection of LSA

As a general principle, SOLAS III/13.1.5 requires that *“Each survival craft shall be stowed as far as practicable, in a secure and sheltered position and protected from damage by fire and explosion.”*

SOLAS II-2/20.3.1.5 further details this principle with respect to closed vehicle spaces, closed ro-ro spaces and special category spaces and requires that *“permanent openings in the side plating, the ends or deckhead of the space shall be so situated that a fire in the cargo space does not endanger stowage areas and embarkation stations for survival craft [...]”*

Chinese Flag Administration, in their domestic regulations, considers that 3 m distance between ro-ro space openings and survival craft stowage areas or embarkation stations is sufficient (IMO, 2018).

7.3.2.4 Protection of essential systems to sustain safe evacuation

SOLAS II-2/22 is applicable to passenger ships with length greater than 120 m or with more than 3 MVZ. It requires that the following systems remain serviceable in the remaining MVZ in case of a fire casualty in any one MVZ or horizontal zone:

- Fire main
- Internal and external communication systems
- Bilge systems
- Lighting along escape routes , at assembly stations and at LSA embarkation stations
- Guidance systems for evacuation

7.4 Fire resistance of LSAs

The following report describes fire requirements for Life-Saving Appliances according to Resolution MSC.48(66): Adoption of the International Life-Saving Appliance (LSA) Code.

Life-saving appliances are split in two groups, i.e. personal life-saving appliances and survival crafts.

7.4.1 Fire requirements for personal life-saving appliances

Table 2 shows the fire requirements for the personal life-saving appliances.

Table 2: Personal live-saving appliances and their fire requirements

Personal life-saving appliances	Fire requirements
Lifebuoys	Lifebuoys shall not sustain burning or continue melting after being totally enveloped in a fire for a period of 2 seconds.
Lifebuoys self-activating smoke signals	Lifebuoys self-activating smoke signals shall not ignite explosively or emit any flame during the entire smoke emission time of the signal.
Lifejackets	Lifejackets shall not sustain burning or continue melting after being totally enveloped in a fire for a period of 2 seconds.
Immersion suits	Immersion suits shall not sustain burning or continue melting after being totally enveloped in a fire for a period of 2 seconds.
Anti-exposure suits	Anti-exposure suits shall not sustain burning or continue melting after being totally enveloped in a fire for a period of 2 seconds.

7.4.2 Fire requirements for survival craft

Table 3 shows the different types of survival craft and their fire requirements.

Table 3: Survival craft and their fire requirements

Life-saving appliances	Fire requirements
Rigid life-rafts	The buoyant material shall be fire-retardant or be protected by a fire-retardant covering.
Lifeboats	Hulls and rigid covers shall be fire-retardant or non-combustible.
Fire-protected lifeboat ³	Fire-protected lifeboat when waterborne shall be capable of protecting the number of persons it is permitted to accommodate when subjected to a continuous oil fire that envelops the lifeboat for a period of not less than 8 min.

³ Not applicable for RoPax (SOLAS III/ 31)

In the Table 3, the terms fire-retardant and non-combustible are used.

A clear definition of fire-retardant can be found in the MSC/Circ.1006 (IMO, 2001). A material that has been declared fire-retardant should have been tested according to ISO 5660-1: Cone Calorimeter Tests.

The ISO 5660-1 cone calorimeter test is a fire reaction test. It tests the flammability tendency of a material by applying a radiant heat flux (50 kW/m² in the present case) during a certain time (here 40 seconds) and observing if the material ignites. If the material does not ignite before 40 seconds (acceptance criteria), the tested material has passed the test.

It can be added that in the MSC/Circ.1006, another term is defined: Flame-resistant. The corresponding fire test consists on the exposition of the tested material to a gas torch (at approximately 1 600 °C) for 1 minute. At the end of this minute, the torch should be removed, and the area of flame impingement should not support combustion more than 30 seconds.

The second term i.e. non-combustible finds its definition in the FTP Code Part 1: Fire testing of materials for shipping, non-combustibility. The procedure of this test consists on the insertion of a test specimen inside a cylindrical furnace tube at 750 °C. The furnace and specimen temperatures are measured continuously during the test. Potential combustion of the test specimen is registered as temperature rise and/or visible flames. Mass loss of the test specimen is calculated after the test. These parameters are used to decide if the product is non-combustible or not.

It should be noted here that the MSC.48(66) does not give any information about the fire requirements for Launching and embarkation appliances, as well as for the Marine Evacuation Systems.

7.5 Generic ships

7.5.1 Identification of types and sizes of ro-ro passenger ships

7.5.1.1 Purpose and method

For the purpose of making the study in FIRESAFE II applicable to a vast part of the world fleet of RoPax, ships were grouped by the following parameters:

- Passenger capacity;
- Lane meter capacity⁴;
- Cargo deck type (closed, open, weather or a combination);
- Size of weather deck (if any).

In order to assess the relevancy of the grouping, it was crosschecked with the Stena fleet of 29 RoPaxes and with data from a world fleet database. When crosschecking with the Stena fleet, type of trade or usage of the ship in a fleet network was also considered. After grouping the ships according to above parameters and the description here, this was checked against a ratio between lane meter and passenger number (LM/Pax ratio). This ratio was proven to match the grouping to a large extent and it is believed it can be used as a key figure when grouping the world fleet.

7.5.1.2 Grouping

Four clear groups emerged: *Ferry-RoPax*, *Large RoPax*, *Standard RoPax*, *Cargo-RoPax*. These groups are described in detail in Table 4.

⁴ Lane meter capacity should be used with great care when considering the world fleet as the measure can differ between operators. Figures used in this report have been provided by EMSA.

Table 4: Typical description of the main groups

<p>Figures below on passenger capacity and lane meter capacity are examples picked from the Stena fleet cross check and shall be seen as examples only. For world fleet grouping LM/Pax ratio is used.</p>				
	Ferry-RoPax	Large RoPax	Standard RoPax	Cargo-RoPax
General description	RoPax or Ferry with focus on carriage of passengers but which can also carry cargo similar to a <i>Standard RoPax</i> .	RoPax with focus on carriage of cargo and of passengers. High lane meter capacity	RoPax with focus on carriage of cargo and of passengers. Standard lane meter capacity.	RoPax with focus on carriage of cargo.
Passenger capacity	900-2 300	600-1 500	900-1400	Just enough to carry the number of drivers necessary to load the ro-ro spaces with accompanied trailers. Less than 400.
Lane meter capacity	1 000-2 300 m	Above 3 000 m	1 000-2 300 m	1 000-2 300 m
Deck type	Only closed ro-ro spaces or mainly closed ro-ro spaces and a small weather deck.	All three types of ro-ro spaces: closed ro-ro spaces, open ro-ro spaces and weather deck. The size of weather deck is generally medium to large within this category.	All three types of ro-ro spaces: closed ro-ro spaces, open ro-ro spaces and weather deck. The size of weather deck is generally medium to large within this category.	Closed ro-ro space and large weather decks.
LM/Passenger	Less than 2	2-7	2-7	More than 7
Visualization	Stena Superfast	Stena Scandinavica or Hollandica	Stena Flavia or Mersey	Stena Gothica
Final Grouping	<i>Ferry RoPax</i>	<i>Standard RoPax</i>		<i>Cargo RoPax</i>

7.5.1.3 FIRESAFE II groups

For the purpose of this study, it was decided to merge *Large RoPaxes* and *Standard RoPaxes*. For trade and usage within a fleet network, the difference between the two groups is acknowledged. This is mainly due to the different harbour arrangements required to accommodate very large ships.

However, there are also several similarities and the total number of *Large RoPaxes* is low. Therefore, the the LM/Pax ratio was retained as the only grouping criteria. Most of the *Large RoPaxes* were merged with *Standard RoPax* and formed the final group *Standard RoPax*.

Therefore, the vessels were grouped using the ratio LM/Pax for grouping. The lane meter to passenger ratio categorized according to the FIRESAFE II Group on the Stena fleet is provided in Figure 3.

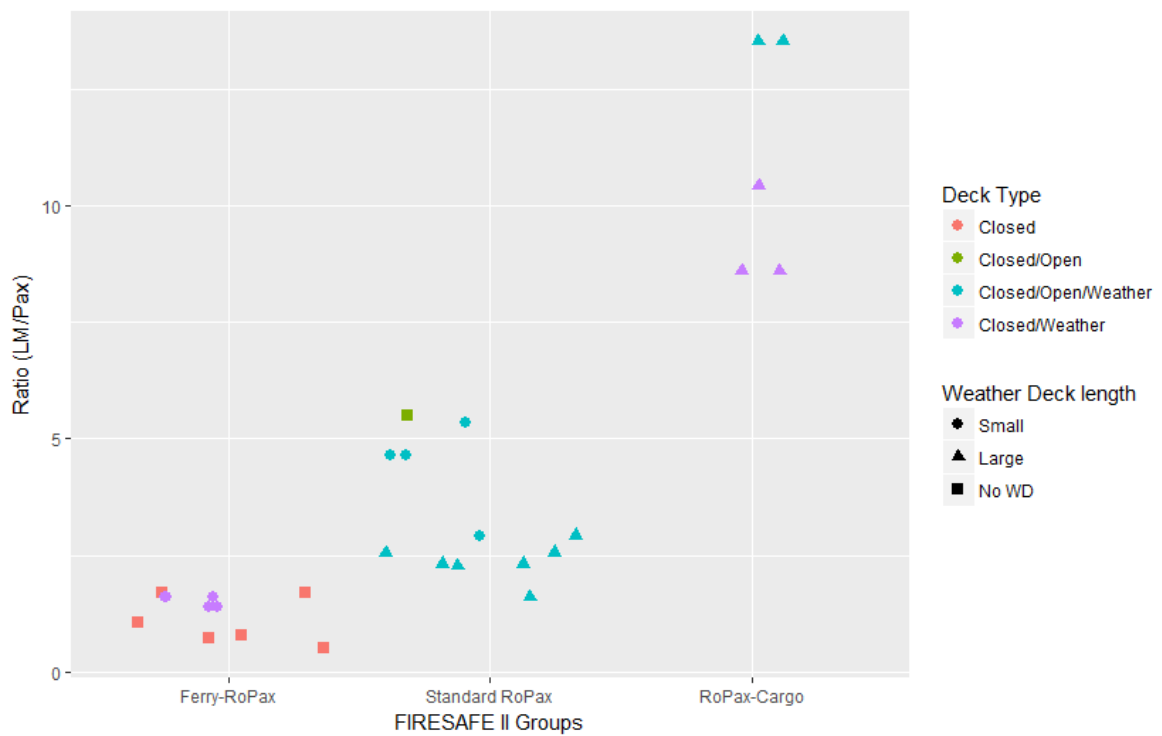

Figure 3: Lane meter to passenger ratio categorized according to the FIRESAFE II Group on the Stena fleet

Not all ships of the FIRESAFE II fleet match all the criteria but the definition can be taken as a guideline. The distribution of the FIRESAFE II fleet (in black) and of the Stena fleet (in colour) in terms of lane meter capacity and number of passengers is provided in Figure 4 along with the borders of the FIRESAFE II groups (red lines). The large circles represent the Stena ships selected as generic ships.



Figure 4: Lane meter capacity vs. number of passengers for the FIRESAFE II fleet (in black) and the Stena fleet (in colour) and FIRESAFE II groups (red lines)

7.5.2 Description of the generic ships chosen for the study

7.5.2.1 Cargo RoPax

This sample ship is a representative design of a *Cargo RoPax* of a size of 13 294 GT. It was designed with a capacity of 186 persons onboard. The vessel is compliant with all relevant international rules and regulations. The ship is designed to SOLAS A.265 and later reconstructed to operate as per the SOLAS 90. Ship has 6 MVZs.

Passenger cabins are located in the superstructure on Deck 4, 5 and 6. Restaurant is located on Deck 6. The remaining part of Deck 4 consists of a garage and weather deck. Deck 2 is the main deck with ro-ro lanes throughout the full length of the ship. Lower hold on Deck 1 is for trailers and trucks. Picture of this ship is provided in Figure 5.

The total ro-ro area (excluding casings etc.) on the *Cargo RoPax* is 4 364 m². 67% of this area is located in closed spaces (lower hold, main deck and garage), the remaining 33% being the weather deck.



Figure 5: Picture of the Stena Gothica (Cargo RoPax ship)

The main characteristics of the *Cargo RoPax* ship are detailed in Table 5 and the cargo decks particulars are further described in Table 6.

Table 5: Main characteristics of the *Cargo RoPax* ship

GENERAL	<i>Cargo RoPax</i>
Length overall	171,05 m
Breath moulded	20,25 m
Draught	5,27 m
Built	1982
Deadweight	4 750 t
Gross tonnage	13 294 t
Net tonnage	3 988 t
Cargo capacity	1 600 lm
Pax capacity	186 pax
Route	Göteborg - Frederikhamn, day and night
Passage time	3,5 hrs
Fire pump 1	71 m ³ /h
Fire pump 2	70 m ³ /h
Emergency fire pump	90 m ³ /h
Drencher pump	288 m ³ /h

Table 6: Description of the cargo decks of the *Cargo RoPax* ship

General description	Weather deck (+ garage), deck 4
Extinguish	Drencher (garage) Fire monitors (WD)
Detection	Heat detectors (garage)
Containment	WD + garage with open aft
Ventilation	Mechanical
Cargo	Standard trailers/trucks
General description	Main Deck, deck 2
Extinguish	Drencher
Detection	Smoke detectors + Heat detectors (Heat det. in drencher section 6, ships length extended)
Containment	Closed ro-ro space
Ventilation	Mechanical
Cargo	Standard trailers/trucks
General description	Lower Hold, deck 1
Extinguish	Drencher
Detection	Smoke detectors
Containment	Closed ro-ro space
Ventilation	Mechanical
Cargo	Standard trailers/trucks

7.5.2.2 *Standard RoPax*

This sample ship is a common and popular design of a RoPax of a size of 26 904 GT. It was designed for with a capacity of more than 880 persons onboard. The vessel is compliant with all relevant international rules and regulations. The ship is designed to and operating as per the SOLAS, 1974. Ship has 6 MVZ.

Passenger cabins are located in the superstructure on Deck 6, above the restaurant on Deck 5. The remaining part of Deck 5 consists of a weather deck for cars. Below on Deck 4 is located an open ro-ro space with a small weather deck in the aft. Deck 3 is the main deck with ro-ro lanes throughout the full length of the ship. A small car deck seldom used (about 82 cars) is located on Deck 2 and some 250 lane metres for trailers and trucks are situated in the lower hold on Deck 1. Picture of the ship is provided in Figure 6.

The total ro-ro area (excluding casings etc.) on the *Standard RoPax* is 9 446 m². The repartition between the different ro-ro spaces is as follows: 53% of closed spaces (lower hold, main deck and car deck), 32% of open spaces (garage) and 5% of weather deck.



Figure 6: Picture of the Stena Flavia (Standard RoPax ship)

The main characteristics of the *Standard RoPax* ship are detailed in Table 7 and the cargo decks particulars are further described in Table 8.

Table 7: Main characteristics of the Standard RoPax ship

GENERAL	<i>Standard RoPax</i>
Length overall	186,5 m
Breath moulded	25,5 m
Draught	6,16 m
Built	2008
Deadweight	5 875 t
Gross tonnage	26 904 t
Net tonnage	8 912 t
Cargo capacity	2 200 lm
Pax capacity	830 pax
Route	Nynäshamn - Ventspils, day and night
Passage time	6-9 hrs, pending timetable
Fire pump 1	110 m ³ /h
Fire pump 2	n/a
Emergency fire pump	110 m ³ /h
Drencher pump	960 m ³ /h

Table 8: Description of the cargo decks of the *Standard RoPax* ship

General description	Weather Deck for cars, deck 5		
Extinguish	None		
Detection	None		
Containment	Weather deck		
Ventilation	None		
Cargo	Standard cars, minivans		
General description	Open ro-ro space/Weather Deck, deck 4		
Extinguish	Drencher (except for WD part)		
Detection	Smoke detectors (except for WD part)		
Containment	Open ro-ro space, side openings >10%, open aft towards small WD and ramp		
Ventilation	Natural + partly mechanical		
Cargo	Standard trailers/trucks		
General description	Main Deck, deck 3		
Extinguish	Drencher		
Detection	Smoke detectors		
Containment	Closed ro-ro space		
Ventilation	Mechanical		
Cargo	Standard trailers/trucks, Various ro-ro units		
General description	Lower Hold, deck 1	General description	Car Deck in lower hold, deck 2
Extinguish	Drencher	Extinguish	Drencher
Detection	Smoke detectors	Detection	Smoke detectors
Containment	Closed ro-ro space	Containment	Closed ro-ro space
Ventilation	Mechanical	Ventilation	Mechanical
Cargo	Standard trailers/trucks	Cargo	Standard cars

7.5.2.3 Ferry RoPax

This sample ship is a common and popular design of a Ferry RoPax of a size of 30 285 GT. It was designed for with a capacity of more than 1 200 persons onboard. The vessel is compliant with all relevant international rules and regulations. The ship is designed to and operating as per the SOLAS 1997 including Stockholm Agreement. Ship has 5 MVZ.

Passenger cabins are located in the superstructure on Deck 8, above the restaurant on Deck 7. The remaining part of Decks 7 and 8 consists of decks for engine casing, life boats and rafts. Below on Deck 5/6 is located a closed ro-ro space with open end to a small weather deck in the aft. Deck 3 is the main deck with ro-ro lanes throughout the full length of the ship. A small car deck is located on Deck 2 and cars and vans are stowed in the lower hold on Deck 1. Picture of the ship is provided in Figure 7.

The total ro-ro area (excluding casings etc.) on the *Standard RoPax* is 9 446m². The repartition between the different ro-ro spaces is as follows: 53% of closed spaces (lower hold, main deck and car deck), 32% of open spaces (garage) and 5% of weather deck.



Figure 7: Picture of the Stena Superfast VIII (Ferry RoPax ship)

The main characteristics of the *Ferry RoPax* ship are detailed in Table 9 and the cargo decks particulars are further described in Table 10.

Table 9: Main characteristics of the *Ferry RoPax* ship

GENERAL	<i>Ferry RoPax</i>
Length overall	203,3 m
Breath moulded	25 m
Draught	6,6 m
Built	2001
Deadweight	5 920 t
Gross tonnage	30 285 t
Net tonnage	10 703 t
Cargo capacity	1 900 lm
Pax capacity	1 200 pax
Route	Belfast - Cairnryan, day and night
Passage time	2,5-3 hrs, pending timetable
Fire pump 1	150 m ³ /h
Fire pump 2	n/a
Emergency fire pump	150 m ³ / h
Drencher pump	285 m ³ /h

Table 10: Description of the cargo decks of the *Ferry RoPax* ship

General description	Cargo Deck, deck 5		
Extinguish	Drencher (except for WD part)		
Detection	Smoke/heat detector (except for WD part)		
Containment	Closed ro-ro space with open aft towards small WD		
Ventilation	Mechanical		
Cargo	This deck has 4 lanes which can take high freight traffic full 50% of crossings, the 2 outside lanes normally have drop trailers or cars.		
General description	Main Deck, deck 3		
Extinguish	Drencher		
Detection	Smoke/heat detector		
Containment	Closed ro-ro space		
Ventilation	Mechanical		
Cargo	Mix of running freight traffic and drop trailers. Cars/vans on busy trips.		
General description	Lower Hold, deck 1	General description	Car Deck in lower hold, deck 2
Extinguish	Drencher	Extinguish	Drencher
Detection	Smoke detectors	Detection	Smoke detectors
Containment	Closed ro-ro space	Containment	Closed ro-ro space
Ventilation	Mechanical	Ventilation	Mechanical
Cargo	Cars, vans.	Cargo	Cars, vans

8 HAZARD IDENTIFICATION

Interested readers can refer to the report for Part 1 (detection and decision) of the FIRESAFE II study for the analysis of casualty data.

8.1 Hazard Identification – Containment

8.1.1 *Review of accident investigation reports*

The goal of this section is an investigation of accident reports to report data related to containment and evacuation.

A total of 22 reports has been investigated. Each report summarizes the historic of the accident as well as recommendations. This section groups the common data and the specificities of each accident.

The following section was based on investigation of documentation of 22 fire accidents on ships. Collected data regarding containment and evacuation was collected and summarized.

8.1.1.1 *Containment of fire and smoke*

Containment is divided into containment of smoke spread and fire spread.

8.1.1.1.1 *Smoke*

In many investigated cases, smoke spread was contained by shutting off the ventilation on decks or in accommodation sections or both. Some other ways mentioned in the documentation were closures of fire doors, dampers (manual closure) and air vents. In case of the fire on Pearl of Scandinavia (as stated in the Marine Accident Report), altering the ship's course and speed was an additional method used for preventing the smoke spread over and along the ferry. In the case of the accident of Amorella, the ventilation was designed in the following way: overpressure was implemented in the accommodation sections and underpressure in the car decks. This design avoided smoke propagation in the passenger compartments, except some minor odours according to the official report. The behaviour of the smoke in this case was the consequence of both stopping the ventilation of the car deck and opening the suction channels and maintaining the ventilation of the cargo spaces in operation.

8.1.1.1.2 *Fire*

Fire spread in accidents described in the investigated reports was prevented by different means and combinations of them:

- Activation of the drencher to extinguish the fire (Knossos Palace)
- Activation of the drencher in adjacent sections to prevent the spread to other cars (Stena Spirit)
- Closing of air vents (Volcan de Taburiente)
- Boundary cooling (Vincenzo Florio)

8.1.1.2 *Issues with containment*

In several investigated cases, some issues regarding containment of smoke and fire were highlighted. A few reports stated spread of smoke to accommodation compartments despite undertaken measures mentioned in the previous section. During the accident on Commodore Clipper, the smoke spread to the accommodation and restaurant area where passengers were mustering even though the ventilation was shut down, fire doors and dampers were closed. In case of fire on Vincenzo Florio, smoke reached the passenger area and an engine room because fire dampers had not been closed. The Marine Accident Report on Stena Spirit stated that walls and doors separating vehicle area from other spaces of the ship were not designed properly and did not create a sufficient fire class division. In the accident on Pearl of Scandinavia, smoke which spread to the accommodation area resulting in re-activation of the ventilation system in mentioned space.

8.1.2 Fire Containment Hazard Identification workshop

A Hazard Identification (HazId) workshop was held at Bureau Veritas in Paris, 22 February 2018. A Fire HazId workshop is a systematic brainstorming session carried out by a multidisciplinary design team, to investigate the fire safety of a specific subject. The selected participants should mirror the diversity of the subject in the sense that they should possess all the necessary competence to identify potential hazards and risk control measures for the specific subject. The focus of this HazId was “fire containment in ro-ro spaces” and the experts gathered are presented in Annex A1.10, along with their expertise in particularly design, fire safety, risk analysis, operation and regulations for ro-ro passenger ships.

A spreadsheet was developed prior to the HazId workshop, to guide the procedure and for documentation of results. The spreadsheet and the HazId procedure was based on a Failure Mode and Effects Analysis (FMEA) risk analysis procedure, which is commonly used in risk management.

Initially in the workshop, different means for fire containment were identified as:

- Fire/flame integrity
- Smoke integrity
- Heat insulation

Before starting to identify failure modes for each means of fire containment, and to assist in this process, desired properties and affecting conditions were identified for the means of fire containment. Thereafter, ship conditions, systems, procedures, etc. were considered to identify failure modes and resulting effects of failure. These were divided on the three types of ro-ro spaces, namely closed ro-ro space, open ro-ro space and weather deck. Associated risk control measures were also identified in relation to each failure mode and significant related comments were noted. This procedure was repeated for each means for fire containment, as long as failure modes could be identified, and then for the other means for fire containment.

Furthermore, prior to the FIRESAFE II study, a more extensive Fire HazId workshop with a more general focus on “ro-ro space fire safety” was commercially organized for Stena by RISE Fire Research in 2015. Participants in that HazId workshop were four research scientists with expertise in risk management, fire safety engineering, fire hazard identification, vehicle fire cause investigation, maritime regulations, ship fire safety and ship surveying, as well as nine senior officers and fleet managers (masters, chief engineers and naval architect) selected for their competence and interest in RoPax fire safety issues. The results from that Fire HazId were not made publicly available but by acceptance from Stena, the results related to fire containment were used to complement the results of the workshop organized within FIRESAFE II. Identified hazards and proposed RCMs from other projects were also incorporated as appropriate and the participants were also given the opportunity to make post-HazId additions.

The resulting tabulation of fire containment hazards and risk control measures is documented in Annex A1.1.

Some notable results from the workshop were:

- Side openings were considered a major hazard for fire and smoke spread to Life Saving Appliances (LSAs), ventilation inlets, decks above, but also end openings pose a significant hazard;
- Openings provide oxygen to the fire;
- A major concern with ro-ro space fires is that the space is not sub-divided, meaning that an uncontrolled ro-ro space fire may involve the whole length of the ship. The fire will quickly grow intense and could last for a very long time (days);
- On general ro-ro cargo ships, fire insulation (A-30) is required between decks, but this is not required on RoPax ships (except every 10 meters in height). Without insulation, fire vertical spread after about 10 minutes is possible (without extinguishing system activated);
- Fire spread to weather deck, due to flame spread through openings or heat transfer through the deck, is difficult to avoid due to lack of fire integrity and limited possibilities for management (only manual efforts, limited equipment, accessibility problems, etc.). Fire spread to weather deck is associated with high risk since there are no fixed means for extinguishment and the accessibility for safe manual firefighting is limited, which gives a high probability of an uncontrolled fire;

- Smoke spread from the ro-ro space to the accommodation part of the ship is a major concern and it is difficult to achieve an over pressure in all spaces adjacent to a ro-ro space; and
- Doors to the ro-ro space are generally not smoke tight, since this is not tested in accordance with the Fire Test Procedure (FTP) Code.

8.2 Hazard Identification – Evacuation

8.2.1 Review of accident investigation reports

The goal of this section is an investigation of accident reports to gather data related to containment and evacuation.

A total of 22 reports has been investigated. Each report summarizes the historic of the accident as well as recommendations. This section groups the common data and the specificities of each accident.

The following section was based on investigation of documentation of 22 fire accidents on ships. Collected data regarding containment and evacuation was collected and summarized.

8.2.1.1 Evacuation

In almost all the investigated accidents passengers gathered in assembly stations designated in evacuation plans. Assembly stations were usually located in the restaurants or decks. In case of fire on Norman Atlantic, passengers moved to the only left safe place located on one of the decks. In some cases, passengers were ordered to put on life jackets. During the accident on Mecklenburg Vorpommern, a survey of evacuation route was done. One example where passengers went back to their cabins from the assembly station, after the fire was distinguished, was accident on Commodore Clipper. In all reported instances, the evacuation was based on alarm or spoken message from one of the crew members. A smooth evacuation was described by LMIU report and took place at Vincenzo Florio ship. All passengers were evacuated safely using the aid of lifeboats and afterwards two assisting vessels.

8.2.1.2 Issues with evacuation

In several reports some issues regarding evacuation were stated.

In case of the accident on Pearl of Scandinavia, smoke reached the accommodation areas and the presence of the passengers was verified by smoke divers. A failure of an early evacuation was observed on Al Salam Boccacio – the process was uncoordinated due to lack of communication within the crew or between the crew and passengers. Passengers jumped into water and tried to reach life rafts. Investigated reports stated two incidents of electricity black out.

In case of fire on Knossos Palace, it took 3 hours to disembark passengers from the ship through emergency exits due to damaged cables providing power to the drawbridge. Eventually, mobile stairs belonging to Olympic Airways and hydraulic lifts from fire brigade were used for disembarkation. In case of fire incident on Vincenzo Florio, fire stopped the engines and only one generator was working, keeping several emergency lights lit. As a consequence, some people got hurt when evacuating.

Another evacuation issue was reported on Stena Spirit, where no adequate evacuation route was designated in the vehicle space. This also impeded the firemen to have access to transported vehicles during firefighting and rescue operations.

Lastly, on Norman Atlantic, some evacuation and rescue means were lost.

8.2.2 Evacuation Fire Hazard Identification workshop

A Hazard Identification (HazId) workshop was held at Bureau Veritas in Paris, 22 February 2018. A Fire HazId workshop is a systematic brainstorming session carried out by a multidisciplinary design team, to investigate the fire safety of a specific subject. The selected participants should reflect the diverse aspects of the subject in the sense that they should possess all the necessary competence to identify potential hazards and risk control measures for the specific subject. The focus of this HazId was “evacuation affected

by a ro-ro space fire” and the experts gathered are presented in Annex A1.11 along with their expertise in particularly design, fire safety, risk analysis, operation and regulations for ro-ro passenger ships.

A spreadsheet was developed prior to the HazId workshop, to guide the procedure and for documentation of results. The spreadsheet and the HazId procedure was based on a Failure Mode and Effects Analysis (FMEA) risk analysis procedure, which is commonly used in risk management.

Initially in the workshop, different means for providing safe evacuation in case of a ro-ro space fire were identified as:

- Protection from heat
- Protection from fire/flames
- Protection from smoke
- Quick evacuation and abandonment.

The last means of safe evacuation (quick evacuation and abandonment) covers general evacuation fire hazards identified in relation to evacuation from a ro-ro space and abandonment from the ship. Before starting to identify failure modes for each means for safe evacuation, and to assist in this process, desired properties and affecting conditions were identified for the means for safe evacuation. Thereafter, ship conditions, systems, procedures etc. were considered to identify failure modes and resulting effects of failure. These were divided on the three types of ro-ro spaces, namely closed ro-ro space, open ro-ro space and weather deck. Associated risk control measures were also identified in relation to each failure mode and significant related comments were noted. This procedure was repeated for each means for safe evacuation, as long as failure modes could be identified, and then for the other means for safe evacuation.

Furthermore, prior to the FIRESAFE II study, a more extensive Fire HazId workshop with a more general focus on “ro-ro space fire safety” was commercially organized for Stena by RISE Fire Research in 2015. Participants in that HazId workshop were four research scientists with expertise in risk management, fire safety engineering, fire hazard identification, vehicle fire cause investigation, maritime regulations, ship fire safety and ship surveying, as well as nine senior officers and fleet managers (masters, chief engineers and naval architect) selected for their competence and interest in RoPax fire safety issues. The results from that Fire HazId were not made publicly available but by acceptance from Stena, the results related evacuation in case of a ro-ro space fire were used to complement the results of the workshop organized within FIRESAFE II. Identified hazards and proposed RCMs from other projects were also incorporated as appropriate and the participants were also given the opportunity to make post-HazId additions.

The resulting tabulation of evacuation fire hazards and risk control measures is documented in Annex A1.2.

Some notable results from the workshop were:

- Side openings were considered a major hazard for fire and smoke spread to LSA, but also end openings pose a significant hazard;
- Smoke may spread from side openings and ventilation outlets and affect the possibilities for using LSA, escape routes, embarkation stations etc.;
- A fire in ro-ro space may block the use of LSA by hindering embarkation or deployment, burning guiding ropes, etc.;
- Many critical cables run through the ro-ro space and fire deterioration may cause loss of power, navigation impossibility, black out etc., regardless of the current provisions;
- Heat spread to escape routes and embarkation stations is critical, in particular if the use of LSA is hindered and since a ro-ro space fire can be very intense and long-lasting;
- It is seldom possible to provide of a secondary means of conventional disembarkation of the ship (not considering use of LSA) when berthing a foreign harbour (where gangways are not usable). Evacuation through the stern ramp may not be possible due to fire; and
- Passengers are generally not allowed in the ro-ro space before the ship is alongside, but if this occurs, fire in a ro-ro space full of passengers is a worst possible evacuation scenario.

9 RISK ANALYSIS

9.1 Background

The purpose of the risk analysis in step 2 of the FSA process, as described in MSC-MEPC.2/Circ.12/Rev.2, is to undertake a detailed investigation of the frequencies and consequences of identified accident scenarios.

This is achieved by using suitable risk models built by means of standard techniques such as fault trees and event trees. The generic methodology applied during risk analysis consists of linking fault trees with the event trees to represent full accident scenarios.

This methodology has been acknowledged in document III 3/4/5 (IMO, 2016) and was used in the FIRESAFE study where three risk models (one event tree and two “fault trees”) were developed to investigate the topics *Electrical Fires as ignition risk* and *Fire Extinguishing Failure*.

In particular, the main fire risk model (event tree) identified the pivotal events which affect the outcome of different fire scenarios in ro-ro spaces and had been developed in such a way that it could be used in future investigations into specific nodes beyond the scope of the first FIRESAFE study.

The main fire risk model was subsequently updated in the first part of FIRESAFE II where a review and update of the model was conducted, leading to the introduction of dedicated branches in the event tree for *Detection*, *First response*, and *Decision*. The updated main fire risk model is described in section 9.2.

In this study, the nodes *Containment* and *Evacuation* (or *fire integrity of evacuation routes and LSAs*) were analytically investigated.

The main fire risk model and the associated sub-models were developed in such a way that it is possible to assess, in quantitative values, the consequences of additional preventing and mitigating measures addressing the risks of containment and evacuation failures.

For containment, dedicated fault trees were developed focusing on the main hazards identified during the HazId. The trees were quantified to gain an understanding of the impacts on risks and to investigate in further detail the important causes and initiating events of the accident scenarios identified. This allowed quantification of the contributing containment failures as well as to calculate the overall containment failure rate. In order to consider the different types of ro-ro spaces, different trees were developed and quantified by investigation of available failure data, fire simulations and expert judgement, in case none of the previous options were available. These trees are further detailed in the section 9.3.

9.2 Main fire risk model

For the purpose of specifically investigating the detection and decision nodes, the main fire risk model developed in FIRESAFE was reviewed and upgraded in the first part of FIRESAFE II. The main modification was the expansion of the former *Decision* node into two nodes, covering *Detection* and *Decision* respectively. The updated chain of events for FIRESAFE II is presented in Figure 8.

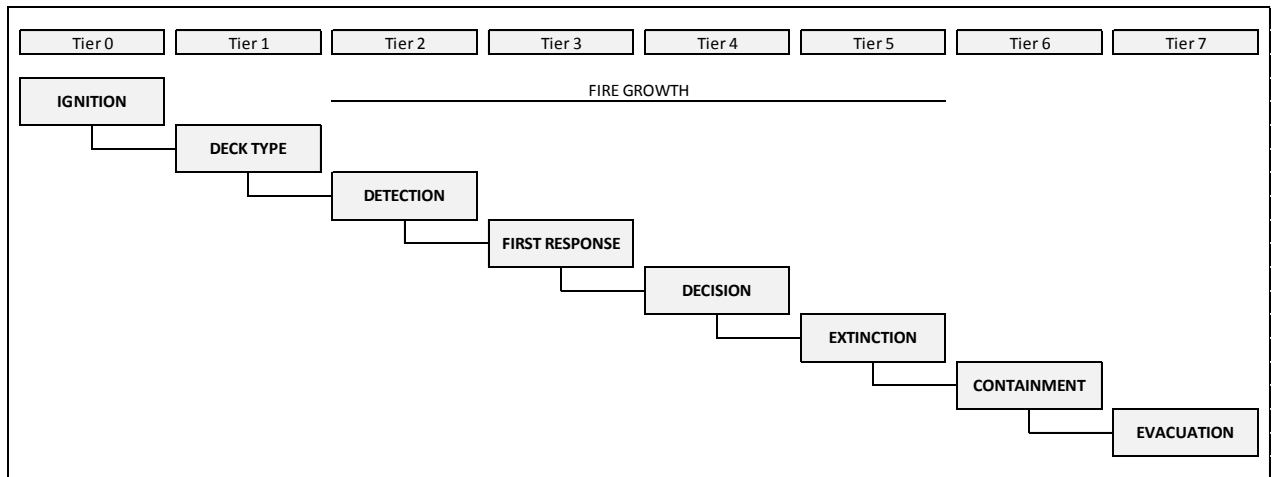

Figure 8: Updated chain of events for FIRESAFE II

As an illustration, the updated Main Fire Risk Model for the *Standard RoPax Newbuilding (Open ro-ro spaces part only)* is shown in Figure 9. The three parts (*Closed ro-ro spaces, Open ro-ro spaces, and Weather Deck*) are shown in the Annex A1.4. The event tree for the *Cargo RoPax* and the *Ferry RoPax* are provided in Annexes A1.3 and A1.5 respectively.

In addition, dedicated fault trees were developed for each generic ship (*Cargo RoPax, Standard RoPax* and *Ferry RoPax*) and potential differences between Newbuildings and Existing ships were taken into account in the detection and decision fault trees. This led to the development of 6 different risk models (*Cargo RoPax Newbuildings, Cargo RoPax Existing ships, Standard RoPax Newbuildings, Standard RoPax Existing ships, Ferry RoPax Newbuildings, Ferry RoPax Existing ships*). The structure of the trees are identical but the quantifications differed.

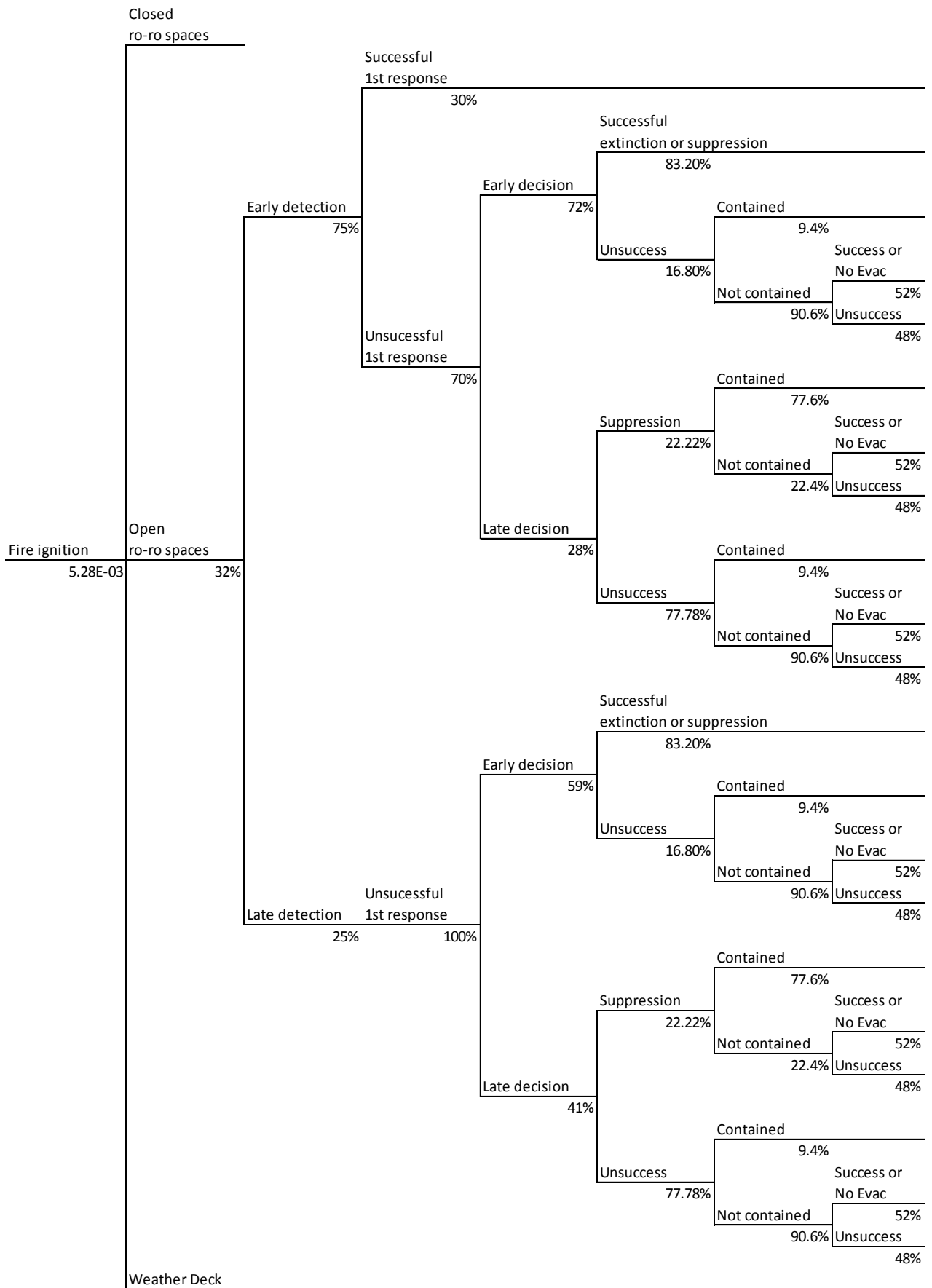

Figure 9: Updated Main Fire Risk Model for the Standard RoPax Newbuilding (Open ro-ro spaces part)

9.2.1 Review of the other nodes

9.2.1.1 Ignition

The Ignition node is extensively elaborated in the FIRESAFE report (EMSA, 2016). The initial accident frequency was updated based on the findings described in the first part of FIRESAFE II (EMSA, 2018). The frequency of fires in ro-ro space was estimated to 5.28E-03 fires in ro-ro spaces per shipyear. However, the apportionment of fire causes was kept identical to FIRESAFE.

9.2.1.2 Deck type

The *Closed ro-ro spaces / Open ro-ro spaces / Weather Deck* proportion varies according to the specific design of the ships. As in FIRESAFE, it was assumed that the risk of ignition is evenly distributed on the different decks, i.e. the probability of fire ignition on a given deck configuration is considered to be proportional to the size of the deck. This is correlated to the amount of cargo transported on that deck and also to the amount of equipment.

The deck type repartition for each of the generic ships was provided in section 7.5.2.

9.2.1.3 Detection

The Detection node was investigated in detail in a dedicated part of FIRESAFE II (EMSA, 2018). The findings from this part were used to quantify the event tree.

The new concept introduced for Early/Late detection is related to whether it is possible to successfully perform first response and extinguish the fire in its initial stage. The criterion for “Early” detection was defined as that the *Available Time for Safe First Response* (the time available until conditions become untenable around the fire, disallowing first response) is longer than the *Required Time for Safe First Response* (the time to detect the fire and to set up actions for first response). Otherwise, the detection was considered to be too late to be able to extinguish the fire at its initial stage (for example with a hand-held fire extinguisher), based on that this cannot be done safely.

9.2.1.4 First response

As first response was out of the scope of this study, the figure found in FIRESAFE for *First response failure* (following an *Early detection*) was kept and no specific fault tree was developed. By definition, first response failure after a *Late detection* was set to 100%.

9.2.1.5 Decision

The Decision node was investigated in detail in a dedicated part of FIRESAFE II (EMSA, 2018). The findings from this part were used to quantify the event tree.

“Early” and “Late” decision should be understood in relation to the fire growth rate. “Early” means that the decision to activate the system has been taken early enough to have a chance to extinguish the fire. “Late” means that the fire is already quite developed, and that it is too late to have a chance to extinguish it. However, the fire will still be suppressed upon system activation.

9.2.1.6 Extinguishment

The Extinguishment node was investigated in detail in the first FIRESAFE study (EMSA, 2016). As the focus of FIRESAFE was on the failure of the fixed fire extinguishing system, the branch *Weather Deck* was collapsed.

In FIRESAFE II, the findings from FIRESAFE were used to quantify the *Closed ro-ro space* and *Open ro-ro spaces* branches of the event tree. Failure of fire extinguishment on weather deck was set to 70% following an *Early Decision* (finding from FIRESAFE) and to 90% following a *Late Decision*.

9.2.1.7 Consequences

The findings of FIRESAFE (EMSA, 2016) were kept to populate the consequence part of the risk model. While the variety of outcomes was recognized, an average value for the number of fatalities is sufficient to calculate a PLL.

A fatality rate of 8% of the Persons On Board was hence used to calculate the average fatalities following the scenario: fire on vehicle deck / escalation / unsuccessful evacuation. When evacuation is successful, a 1 equivalent fatality fixed value was assigned to take into account the frequent injuries and possible indirect fatalities following such evacuation. No fatalities were considered in the other cases.

Consequences for property (cargo and ship) were also discussed in FIRESAFE and the same values were assumed in FIRESAFE II for the purpose of calculating the Potential Loss of Cargo (PLC) and Potential Loss of Ship (PLS). The consequences following a fire put out by the crew (manual first response) was considered identical as a fire detected early and put out by means of the drencher system.

9.3 Containment Fault tree

A fault tree was developed to model ro-ro space fire containment failure based on the fire containment hazards identified in the Hazard Identification workshop (see 8.1.2). The expression fire containment was here defined as avoidance of propagation of fire and smoke to impede safe stay on board.

The failure probabilities are dependent on the type of ro-ro space, the type of ship (Cargo, Standard or Ferry) and if the ship is a Newbuilding or Existing. While the structure of the tree remains the same for both closed and open ro-ro spaces, the quantifications differ. In the absence of volume limitations for weather deck, the structure of the tree was adapted to model containment failure for this particular type of ro-ro space.

According to the main fire risk model (Figure 9), failure of fire containment can have various histories as background, but they can be divided in two groups: successful suppression and unsuccessful suppression of the fire. As a reminder, fire suppression implies a sharp reduction of the heat release rate of the fire and prevention of regrowth (definition according to MSC.1/Circ.1430, (IMO, 2012))

9.3.1 Structure of the containment fault tree

As described above, fire containment failure is a failure involving fire or smoke spread. In order to keep the fault tree readable, the fault tree was divided in these two main branches: failure of fire containment and failure of smoke containment. This is illustrated for closed ro-ro spaces in Figure 10 and each of the main branches are further described below.

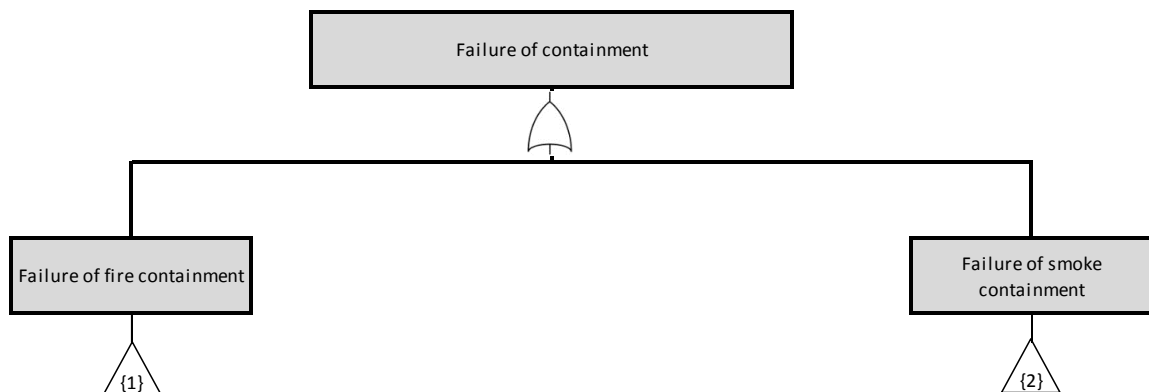

Figure 10: Containment fault tree for closed and open ro-ro spaces

9.3.1.1 Failure of fire containment

Fire containment failure was divided into *Flame spread through openings* and *Heat spread* (see Figure 11), based on the physical properties of a fire. The propagation modes of a fire are conduction, convection and radiation, where the convection and radiation modes are mainly related to the flame of a fire. On other hand,

the conduction mode is based on the availability of a solid media surrounding the fire. The two branches for flame spread through openings and heat spread are further elaborated below.

9.3.1.1.1 Flame spread through openings

Flame spread through openings implies that fire spreads to another space, such as weather deck or the accommodation part of the ship, through ro-ro space openings. The term “openings” represents all kinds of openings, both intended openings (open doors, side openings, end openings, ventilation openings, etc.) and unintended openings (unsealed doors, cracks, unsealed penetrations, etc.). They were sorted in four main categories:

- Aft and side openings

In closed and open ro-ro spaces, openings often exist in the side and ends, which can allow a fire to propagate.

- Doors open

Even if safety measures (e.g. automatic closing device, alarm, etc.) are present to avoid that a door stays open, the possibility of an open door is realistic and should be taken in account.

- Unsealed penetration

Various installations in ro-ro spaces require penetrating the decks and bulkheads (e.g. new wire or pipe penetrations), which might not be totally sealed to avoid the passage of flames.

- Cracks

Cracks in decks or bulkheads are common after a few years of service.

9.3.1.1.2 Heat spread

Heat spread implies conduction heat transfer leading spread of the fire to an adjacent space. Critical spread of heat from a fire can be avoided for a significant time by the use of fire insulation, but it can also be avoided by manual boundary cooling. This branch was therefore divided in the parts:

- Failure of boundary cooling

In order to stop heat propagation, boundary cooling is an approach commonly used on ships, where the exterior surfaces of the fire enclosure are manually cooled by water. However, depending of the position of the fire, boundary cooling might not be feasible, e.g. due to limited access for the crew.

- Fire insulation failure

Fire insulation in ro-ro spaces might have been removed (e.g. for maintenance operations) and not replaced. There are also areas where heat bridges may occur due to the way insulation is installed and required in accordance with SOLAS. Hence, there are two possible insulation failures related to the non-existence of fire insulation, and it may also be the case that the performance of the existing insulation is deteriorated:

- No fire insulation
- Heat bridge accepted by SOLAS
- Insulation performance failure

The cases where the fire insulation might present problems with its performance were categorized accordingly:

- Bad condition of the fire insulation: A greasy or dusty fire insulation gives decreased performance.
- Damage/Gaps of the fire insulation: Damage or gaps in the fire insulation imply a local reduction in the performance.
- Intensive/Long fire: An intensive or long fire will degrade the fire insulation and eventually allow enough heat transfer for fire spread.

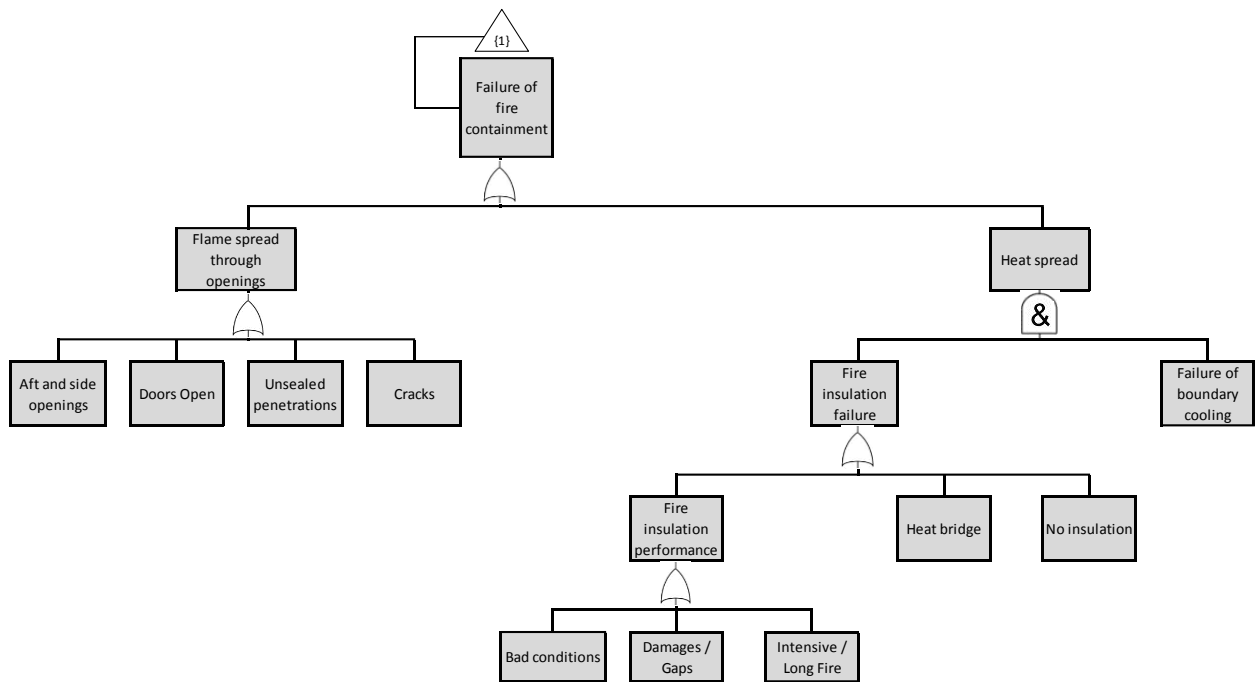

Figure 11: Sub-tree for failure of fire containment for closed and open ro-ro spaces

9.3.1.1.3 Fire spread from weather deck

As noted above, the structure of the containment fault tree for weather deck was made slightly different from that for closed and open ro-ro spaces. As the weather deck is an open area and not a space (limited in volume unlike open and closed ro-ro spaces), no openings are needed for flame spread and the probability for heat spread is also less intricate. Failure of fire containment was for weather deck therefore simply divided in the nodes *Flame spread* or *Heat spread*, as illustrated to the left in Figure 12.

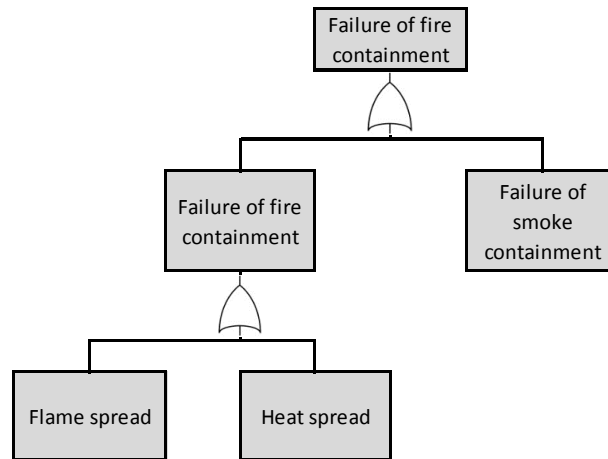

Figure 12: Containment fault tree for weather deck on *Standard RoPax Newbuilding*.

9.3.1.2 Failure of smoke containment

Failure of smoke containment was characterized in two categories: *External smoke spread* and *Internal smoke spread*, elaborated below and illustrated in Figure 13.

9.3.1.2.1 External smoke spread

Containment failure due to external smoke spread occurs when a significant amount of smoke is generated and impedes a safe stay onboard, for example by externally spreading to the accommodation part of the ship, spreading to engine room air intakes or ventilation inlets, blocking or impeding stay on the bridge, preventing use of LSAs, etc. This mode of failure is only relevant when two sub-failures occur at the same time:

- Smoke spread through openings; and
- Failure of navigation in a way to avoid smoke impeding a safe stay onboard.

9.3.1.2.2 Internal smoke spread

Internal smoke spread implies spread of smoke within the ship, in particular to the accommodation part of the ship, impeding a safe stay onboard. As for the previous failure mode, internal smoke spread is only relevant when two sub-failures occur at the same time:

- Failure to create under pressure; and
- Weakness of divisions' smoke tightness.

Internal smoke spread the ro-ro space is hence possible if the pressure in the ro-ro space is higher than the pressure in the adjacent spaces, which is often the case during a fire. To avoid internal smoke propagation, the pressure of the ro-ro space must stay lower than that in surrounding spaces, or it must be ensured that the divisions are smoke tight. The latter may be compromised for several reasons:

- Failure of fire dampers, by not being closed or leaking;
- Failure of deck or bulkhead, by damages or cracks (even small cracks or damages may allow the passage of smoke) or by unsealed penetrations, due to various installations have not be totally sealed; or
- Door failure, by a door being left open or due to gaps in or around the door.

Gaps in the door can be related to damages in the door, allowing the passage of smoke, or that there is a gap in the door allowed by the test according to the FTP code. The latter is hence a prescriptive design of the door which has passed the FTP Code test, but where a gap under the door has been approved due to the test set-up, where there is an under-pressure at the bottom of the door and not an over-pressure over the whole door, as in a real fire scenario.

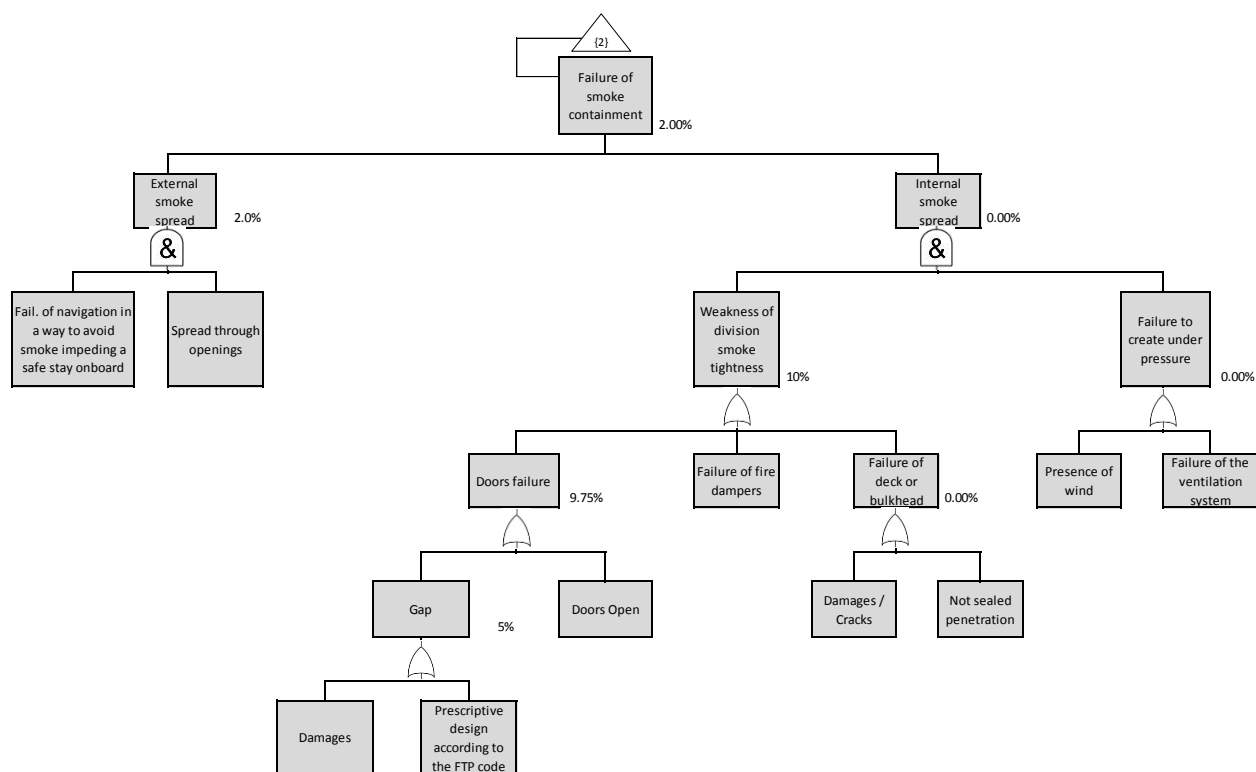

Figure 13: Sub-tree for failure of smoke containment for closed and open ro-ro spaces.

9.3.1.2.3 Smoke spread from weather deck

As for the failure of the fire containment, the structure of the failure of smoke containment event tree for a weather deck was simplified. As explained above, the weather deck is an open area and not a space (limited in volume, as open and closed ro-ro spaces). Failure of containment due to failure of smoke containment was therefore reduced to containment failure by external smoke spread, i.e. smoke spread impeding a safe stay onboard by impacting a critical part of the ship (e.g. by spreading to the accommodation part of the ship, to engine room air intakes or ventilation inlets, or by blocking or impeding stay on the bridge, preventing use of LSAs, etc.). The weather deck containment fault tree is illustrated in Figure 12, with the failure of smoke containment branch to the right.

9.3.2 Methodology for the quantification of the containment fault tree

After developing the structure of the containment fault trees, quantification of the trees was done separately by each partner involved in the study. The estimations were made mainly based on expert judgements and in two rounds. After each round a coordinating partner summarized the results as well as the arguments for the expert judgements. The results were reviewed together, with focus on nodes with large differences. For these nodes, the partners presented their arguments and were given the opportunity to revise their judgements, based on potential new arguments brought to the table by other partners. For many nodes, the expert judgements thus converged towards a more unified estimation, but for some nodes the partners chose to stand by their diverging opinion. The factors affecting the quantifications are summarized in Annex A1.6, together with the results of the quantifications of all containment fault trees. The end results and the main arguments for the quantifications are briefly summarized below.

9.3.3 Quantifications of the containment fault tree

The containment failure probability depends on the type of ship (*Standard RoPax*, *Cargo RoPax* and *Ferry RoPax*), whether it is a newbuilding or existing ship, whether suppression of the fire was successful or unsuccessful and on the type of ro-ro space considered (closed ro-ro space, open ro-ro space and weather deck). The initial quantifications of the fault trees were done for a *Standard RoPax* newbuilding, and these were then altered after comparison with the other ship types, as elaborated in 9.3.3.2, and depending on whether it was a newbuilding or an existing ship, described in 9.3.3.1.

A similar approach was used for the quantification of the *Standard RoPax* fault tree, where initial estimations were made for closed ro-ro spaces, and these estimations were then used as starting point for alterations for open ro-ro spaces. The quantified main nodes of these fault trees were also revisited when quantifying the weather deck fault tree.

The quantifications of the containment fault tree nodes for a *Standard RoPax* newbuilding were made by first quickly estimating all of the bottom nodes in the fault tree, which is generally done with a judgement of relation in their magnitude. Thereafter, these estimations are repeatedly tested based on different arguments and consistency checks, providing some kind of justification to the alterations.

Hence, first the bottom nodes for flame spread through openings were estimated with consideration to a relation between the nodes in this cluster (see Figure 10) and with consideration to potential historical data. Then the rest of the bottom nodes were estimated quickly in relation to these nodes. The relation between for example Flame spread through openings and Heat spread was then considered for a consistency check and the figures in the bottom node clusters were adjusted collectively to find the correct relation between the higher nodes. The consistency checks are repeated until reaching the top node. Since many much of this procedure is based on relative differences, it is important to include as much historical data as possible to find a reliable top node. Reference was therefore made to previous accident investigation reports as much as possible (see 8.1.1).

The resulting quantifications of the containment fault tree are described subsequently, starting from the top nodes and associated probabilities down to each basic event. The fault tree is illustrated in Figure 10. It should be noted that this top-down approach does not represent the methodology applied for the fault tree quantification by the experts, which was done from the basic events to the top node.

9.3.3.1 Influence of the ro-ro space type on the probabilities for containment failure

As shown in the Figure 10, failure of containment stems from either failure of fire containment or failure of smoke containment. The quantifications of these nodes depend on the successfulness of suppression as shown in Table 11 and further described below.

Table 11: Probabilities of containment failure due to smoke or fire containment failure for *Standard RoPax* Newbuildings. 90% confidence interval is indicated in square brackets.

	Probability of containment failure	Probability of fire containment failure	Probability of smoke containment failure
Closed ro-ro space			
Fire suppression	12.8% [6.6%; 22.7%]	2%	11%
Unsuccessful suppression	62.5% [44.7%; 79.4%]	39%	38%
Open ro-ro space			
Fire suppression	22.4% [10.9%; 37.7%]	10%	14%
Unsuccessful suppression	90.6% [86.8%; 94.3%]	81%	51%
Weather deck			
Fire suppression	95.0% [93.5%; 96.4%]	63%	87%
Unsuccessful suppression	99.0% [98.6%; 99.4%]	85%	93%

The probability of containment failure in case of fire suppression is high for the weather deck, since it is an open area. It will not collect the heat from the fire as well as an enclosed space and smoke will in most cases disperse in the air or move away from the ship. However, since there are no fixed means for fire extinguishment or active containment (boundary cooling) and divisions towards the weather deck are generally uninsulated, the probability for containment failure was considered high, regardless of suppression success. There is a slight difference between failure probabilities depending on successful or unsuccessful fire suppression, since the effect of manual suppression in case of a large fire on weather deck were considered to have a small effect, mainly delaying fire spread.

The low probabilities associated with containment failure for closed ro-ro spaces are mainly caused by the low number or even absence of openings. This is elaborated in Table 12 and Table 13 for the fire containment failure branch, and in Table 16 for the smoke containment failure branch, where the bottom nodes can be compared to those for open ro-ro spaces. The probability of containment failure for open ro-ro space is hence higher than for closed ro-ro spaces mainly owing to the potential for flame and smoke spread through openings, both in case of successful and unsuccessful fire suppression.

Uncertainty analysis on the probability of containment failure was performed (methodology followed is detailed in section 12.5 and Annex A2 of the report for Part 1 of the FIRESAFE study (EMSA, 2018)). The estimated confidence intervals are reported in Table 11 and an illustration of the containment failure probability distributions for the *Standard RoPax* Newbuildings is provided in Figure 14.

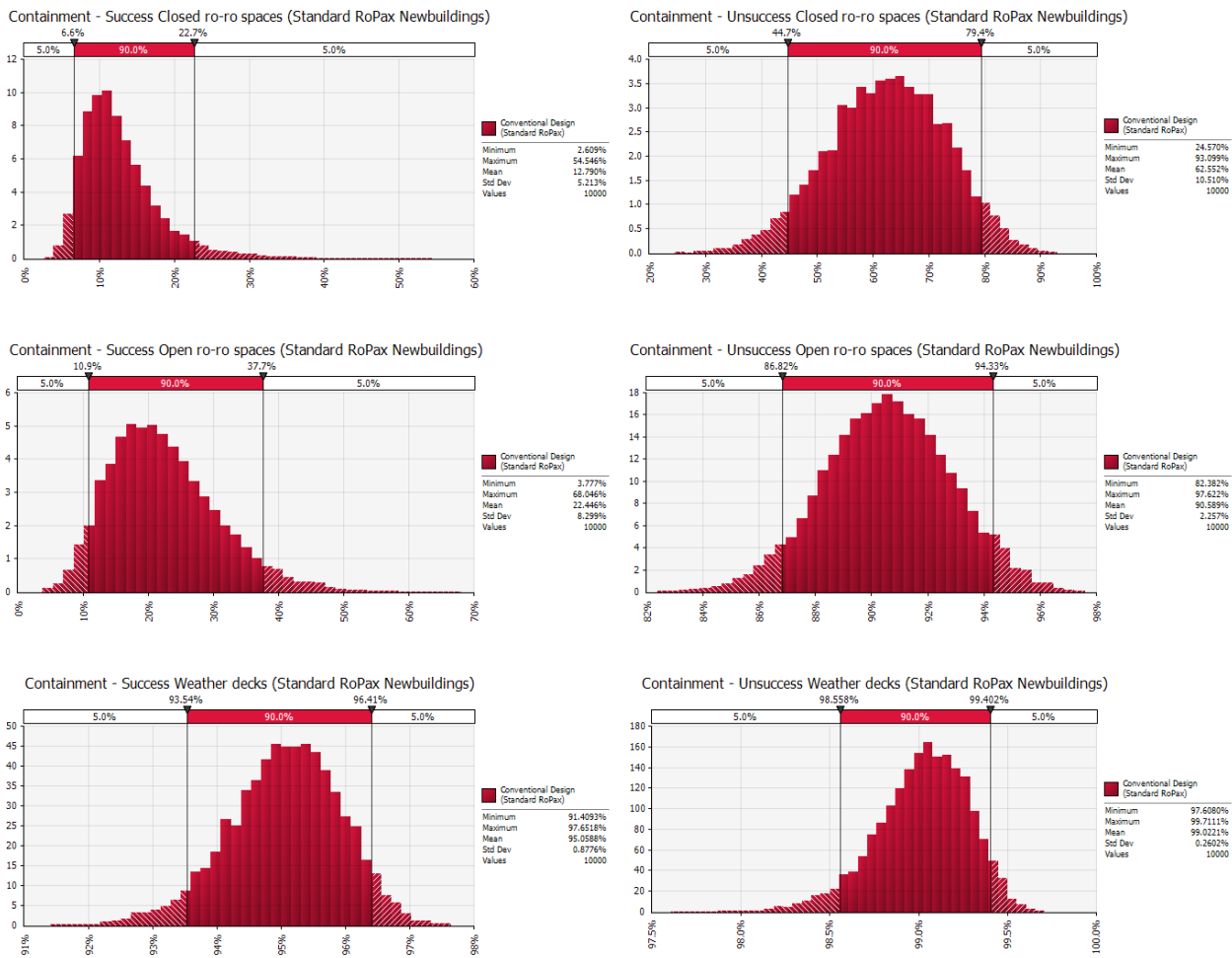

Figure 14: Distributions of the probability of Containment failure on Closed ro-ro spaces, Open ro-ro spaces and Weather decks of the *Standard RoPax* Newbuildings, according to the outcome of Extinguishment node,

9.3.3.1.1 Fire containment failure quantification

Fire containment failure is caused by *Flame spread through openings* or *Heat spread*, as explained in paragraph 9.3.1.1.

Table 12: Probabilities of fire containment failures due to flame or heat spread for *Standard RoPax* Newbuildings

	Probability of Fire containment failure	Probability of Flame through openings	Probability of Heat spread
Closed ro-ro space			
Fire suppression	2%	1.2%	0.8%
Unsuccessful suppression	39%	8%	34%
Open ro-ro space			
Fire suppression	10%	9%	1.2%
Unsuccessful suppression	81%	71%	34%
Weather deck			
	Probability of Fire containment failure	Probability of Flame spread	Probability of Heat spread
Fire suppression	63%	23%	52%
Unsuccessful suppression	85%	45%	73%

The main failure mode following a fire on weather deck was considered to be heat spread, i.e. fire was considered more likely to propagate by conduction into the structure than by radiative heat spread from flames. The flames can be considered as a short-range propagation mode and heat spread as a long-range propagation mode, spreading through the often uninsulated structure of the ship. In the case of unsuccessful fire suppression, the relation between heat spread and flame spread is reduced due to the assumed larger impact from flames.

In case of unsuccessful fire suppression in an open or closed ro-ro space, the highest probability of failure was considered to be caused by heat spread for closed ro-ro spaces, and due to flame spread through openings for the open ro-ro space. However, the probability for heat spread was kept approximately the same for closed and open ro-ro spaces.

The probabilities of flame spread through openings for the different types of ro-ro spaces are shown in Table 13.

Table 13: Probabilities for flame spread through openings for *Standard RoPax* Newbuildings

	Probability of Flame spread through openings	Probability of presence of openings	Probability of door open	Probability of non-sealed penetration	Probability of presence of cracks
Closed ro-ro space					
Fire suppression	1.2%	0.75%	0.20%	0.20%	0.03%
Unsuccessful suppression	8%	4.83%	1.00%	2.3%	0.4%
Open ro-ro space					
Fire suppression	9%	8.75%	0.07%	0.16%	0.08%
Unsuccessful suppression	71%	70%	0.83%	2.17%	0.40%

The probability of flame spread through openings (both intended and unintended openings, as described in paragraph 9.3.1) is mainly caused by intended openings. Therefore, the probability of flame spread is 10 times higher in an open ro-ro space than in a closed one (for both successful and unsuccessful fire suppression). The probability of door open is very low because of the presence of automatic closing devices or an indicator in the wheelhouse of open doors to the ro-ro space. Furthermore, the probability of flame spread through non-sealed penetrations was estimated low due to procedures in case of reconstructions involving penetrations (how to seal penetrations and verification).

In case of unsuccessful fire suppression, the probability of flame spread through openings was considered 8 times more important than in case of successful fire suppression.

As shown in Figure 11, loss of fire containment due to heat spread failure is a combination of boundary cooling failure and insulation failure, which in turn was divided in three main failure nodes. The probabilities of these four failures contributing to heat spread failure in the closed ro-ro space of *Standard RoPax* Newbuilding are presented in Table 14. The probabilities are divided in whether fire suppression is successful or not, which is very determining for the potential of heat spread failure, as shown in Table 12. Furthermore, the specific failure probabilities contributing to insulation failure are presented in Table 15.

Table 14: Probabilities for heat spread for *Standard RoPax* Newbuildings

	Probability of Heat spread	Heat spread due to insulation performance	Heat spread due to heat bridge	Heat spread due to no insulation	Heat spread due to failure of boundary cooling
Closed ro-ro space					
Fire suppression	0.8%	8.29%	3.47%	5.17%	5.17%
Unsuccessful suppression	34%	87%	23%	62%	35%
Open ro-ro space					
Fire suppression	1.2%	10.5%	3.47%	7.83%	5.83%
Unsuccessful suppression	34%	86%	20%	72%	35%

The probability of heat spread due to failure of boundary cooling was estimated to around 5% in case of fire suppression for both closed and open ro-ro spaces. This probability was based on the total surface that cannot be reached for boundary cooling. In case of an unsuppressed fire, the reliability of boundary cooling as well as the difficulties of access led to an estimated failure probability of 35%.

Table 15: Probabilities of failures causing heat spread due to insulation failure for closed ro-ro spaces on *Standard RoPax* Newbuildings

	Probability of Heat spread from insulation failure	Heat spread due to insulation in bad condition	Heat spread due to insulation damage/gaps	Heat spread due to intensive/ long fire
Closed ro-ro space				
Fire suppression	8.29%	1.67%	2.00%	4.83%
Unsuccessful suppression	86.6%	7.33%	13.00%	83.33%
Open ro-ro space				
Fire suppression	10.5%	2.50%	1.83%	6.5%
Unsuccessful suppression	86.1%	9.5%	8.17%	83.33%

The differences in probabilities for the insulation failure are mainly owing to the impact of an intensive or long-lasting fire. The probability of contamination of the fire insulation to such a degree that it is in such bad

condition that it will likely allow heat spread was estimated to 1.5%. For closed ro-ro spaces, a 5 times higher probability was assumed in case of a large fire, due to a bigger impact of the fire on the fire insulation. The probability of contamination for an open ro-ro space was assumed slightly higher than for a closed ro-ro space because of the increase exposure to harsh weather conditions. For open ro-ro spaces, a 4 times higher probability in case of a large fire was assumed due to a bigger impact of the fire on the fire insulation. The probability of failure of insulation performance in case of unsuccessful extinguishment was estimated high (83.33%). In case of successful fire suppression, the heat wave will still go through the fire insulation but with a sharp reduction of intensity, giving an estimated failure probability of around 5% for both closed and open ro-ro spaces.

9.3.3.1.2 Smoke containment failure quantification

The probabilities for smoke containment failure are presented in Table 11. Its main branches and quantifications (see Figure 13) are summarized in Table 16.

Table 16: Probabilities of failures causing smoke containment failure for the case of the *Standard RoPax Newbuildings*

	Probability of Smoke containment failure	Probability of External smoke containment failure	Probability of Internal smoke containment failure
Closed ro-ro space			
Fire suppression	11.0%	0.5%	10.6%
Unsuccessful suppression	38.4%	1.0%	37.8%
Open ro-ro space			
Fire suppression	13.7%	11.3%	2.7%
Unsuccessful suppression	51.0%	49.0%	3.4%
Weather deck			
	Probability of smoke containment failure = Probability of external smoke containment failure		
Fire suppression	86.7%		
Unsuccessful suppression	93.3%		

The probability of smoke containment failure was assessed high and close to 100%, regardless of a suppressed or unsuppressed fire. Smoke cannot be contained on a weather deck but effects on the rest of the ship depend on several factors. The smoke from a fire on a weather deck can propagate either to the stern of the ship, to the air intakes for the engine room, or to the bow, where accommodation ventilation inlets are located. The probability of smoke containment failure was assumed higher in case of an unsuppressed fire than for a suppressed fire. The probability of smoke spread on weather deck causing containment failure was estimated to 87% and 94% for a suppressed fire and unsuppressed fire, respectively.

Table 16 also shows the main differences in terms of smoke containment failure probabilities for the closed and open ro-ro spaces. For the closed ro-ro space, the failure of smoke containment is mainly due to internal

smoke containment failure, while for open ro-ro spaces this failure is due to external smoke containment failure. This difference finds its explanation in the large number of openings for open ro-ro spaces.

External smoke spread was assumed to occur in case of smoke spread through the openings and failure of navigation in a way to avoid smoke impeding a safe stay onboard. The probabilities for these bottom nodes of external smoke containment failure for the open ro-ro space of the *Standard RoPax* Newbuilding are presented in Table 17.

Table 17: Probabilities of failures causing external smoke containment failure for *Standard RoPax* Newbuildings

	Probability of external smoke containment failure	External smoke containment failure due to failure of navigation	External smoke containment failure due to spread through openings
Closed ro-ro space			
Fire suppression	0.5%	6.33%	7.67%
Unsuccessful suppression	0.99%	9.00%	11.00%
Open ro-ro space			
Fire suppression	11.3%	13.3%	85.0%
Unsuccessful suppression	49.2%	50.0%	98.3%

In case of an unsuppressed fire, the fire continues to produce smoke to exit through openings, explaining the difference for the branch “Spread through openings” but also for the branch “Failure of navigation in a way to avoid smoke impeding a safe stay onboard”. Indeed, it may be difficult for the master to manoeuvre the ship with a large amount of smoke, reducing the visibility and increasing the difficulty to choose the right position of the ship with regard to the wind and its effect on the smoke. For closed ro-ro spaces, the probability of this failure was estimated a bit less than 10 times higher than for flames exiting through openings. In case of an unsuppressed fire, the probability was increased by 50%, which is the rough probability to have a worst-case wind direction. For the open ro-ro space case, this probability of failure was estimated to be a bit less than 50% higher than for flames exiting through openings. In case of an unsuppressed fire, the probability of smoke spread towards the accommodation part of the ship was represented by the probability of a worst-case wind direction.

The probability of internal smoke containment failure for the closed ro-ro space of the *Standard RoPax* Newbuildings occurs when two sub-failures occur at the same time: failure to create under pressure in the ro-ro space, and weakness of division smoke tightness. The probability for failure to create under pressure is not dependent on the success or unsuccess of fire suppression, since as soon as a fire is present in a closed ro-ro space, it is quite difficult to create under pressure without any dedicated such system. This node was not further elaborated. However, failure in the divisions smoke tightness depends on whether the fire is suppressed, which generates a lot of smoke and implies a higher pressure in the closed ro-ro space. This higher pressure gives a higher stress on fire dampers and leads to a higher failure rate of deck and bulkhead (in terms of damage/cracks and not sealed penetrations). Failure of the divisions’ smoke tightness was divided in the three nodes Door failure, Failure of fire dampers, and Failure of deck or bulkhead. The former was divided in three causing failures, with probabilities described in Table 18.

Table 18: Probabilities of Door failures causing weaknesses in division smoke tightness and thus internal smoke spread failure for closed ro-ro spaces on *Standard RoPax* Newbuildings

	Probability of internal smoke spread due to weakness in division smoke tightness by door failure	Weakness in division smoke tightness due to door failure (Gap: damage)	Weakness in division smoke tightness due to door failure (Gap: pres. design)	Weakness in division smoke tightness due to door failure (Open)
Closed ro-ro space				
Fire suppression	10%	2.0%	4.0%	4.3%
Unsuccessful suppression	27%	4.0%	20.3%	4.7%
Open ro-ro space				
Fire suppression	5.6%	1.2%	2.0%	2.4%
Unsuccessful suppression	6.4%	2.1%	2.0%	2.4%

For the branch “Door failure” in a closed ro-ro space, the probability to have a door left open was assumed the same for suppressed and unsuppressed fire. The main difference in terms of door failure probabilities is explained by the over-pressure from the smoke in the ro-ro space and applied to a door, fire tested according to the FTP Code (see the paragraph 9.3.1.2). The experts also considered that in an open ro-ro space, the smoke will first come out from the side openings. It will take a significant time for the space to be saturated with smoke to the extent that it goes through the bottom gap of the doors.

The node Failure of fire dampers is only relevant for closed ro-ro spaces and was estimated to occur in 1.3% and 6.7% of the suppressed and unsuppressed fires, respectively.

The branch “Failure of deck or bulkhead” concerning Weakness of division smoke tightness was divided in the sub-nodes Damages/Cracks and Not sealed penetration, with probabilities described in Table 19. It may be noted that the influence of the fire condition (suppressed or not suppressed) was not considered to influence Internal smoke containment failure for an open ro-ro space.

Table 19: Probabilities of deck or bulkhead failures causing weaknesses in division smoke tightness and thus internal smoke spread for *Standard RoPax Newbuildings*

	Probability of internal smoke spread due to weakness in division smoke tightness by Failure of deck or bulkhead	Weakness in division smoke tightness (Failure of deck or bulkhead: Damage/Cracks)	Weakness in division smoke tightness (Failure of deck or bulkhead: Not sealed penetration)
Closed ro-ro space			
Fire suppression	0.2%	0.1%	0.1%
Unsuccessful suppression	11.0%	2%	9%
Open ro-ro space			
Fire suppression	6.8%	1.2%	5.7%
Unsuccessful suppression	6.8%	1.2%	5.7%

The probability of smoke spread due to damage/cracks for a closed ro-ro space was assumed to be 10 times higher than for flame spread through damage/cracks. For open ro-ro spaces, in case of internal smoke spread, no differences were assumed between a suppressed and an unsuppressed fire because smoke will spread easier externally. The probability of smoke spread was estimated to be 5 times higher than for flame spread in case of damage/cracks.

For open ro-ro spaces, the probability of smoke spread through unsealed penetrations was assumed to be twice as high as compared to flame spread. For closed ro-ro spaces, the probability of smoke spread was considered to be 5 times higher than for flame spread, due to the higher potential for building up over pressure in closed ro-ro spaces.

9.3.3.2 Fire containment failure quantification for Ferry and Cargo RoPax

Impacts on fire containment failure depending on the ship type (*Standard RoPax*, *Ferry RoPax* and *Cargo RoPax*) were estimated in relation to *Standard RoPax*, Newbuildings, as elaborated below. Differences in impact on fire containment were above identified for *Standard RoPax* ships depending on whether the preceding fire was successfully or unsuccessfully suppressed, but no such differences were found to depend on the ship type.

Seven nodes of the containment fault tree were identified to be affected by the ship type. Since open ro-ro spaces were only considered on *Standard RoPax* ships, differences were only quantified for closed ro-ro spaces and weather deck, existing on all ship types. The estimated differences depending on the ship type for closed ro-ro spaces are presented in Table 20 and elaborated below.

Table 20: Differences in containment failure probabilities (bottom nodes) for closed ro-ro spaces depending on ship type (relative to *Standard RoPax*)

<i>Ro-ro space</i>	<i>Affected nodes</i>	<i>Cargo</i>	<i>Standard</i>	<i>Ferry</i>
Closed	Successful suppression/Failure of fire containment - Flame spread through openings - Openings	2220%	100%	1000%
	Unsuccessful suppression/Failure of fire containment - Flame spread through openings - Openings	155%	100%	344%
	Failure of fire containment - Flame spread through openings – Doors open	30%	100%	150%
	Failure of fire containment – Heat spread – Insulation failure – No fire insulation	75%	100%	100%
	Failure of fire containment - Heat spread - Failure of boundary cooling	70%	100%	150%
	Failure of smoke containment - External smoke spread - Failure of navigation in a way to avoid effects on evacuation and spread to accommodations	25%	100%	100%
	Successful suppression/Failure of smoke containment - External smoke spread - Spread through openings	293%	100%	350%
	Unsuccessful suppression/Failure of smoke containment - External smoke spread - Spread through openings	205%	100%	244%
	Failure of smoke containment - Internal smoke spread - Weakness of division smoke tightness - Doors failure - Doors open	30%	100%	150%
	Failure of smoke containment - Internal smoke spread - Failure to create under pressure - Failure of the ventilation system	65%	100%	103%

The failure of containment due to flame spread through **Openings** for closed ro-ro spaces on a *Standard RoPax* ship is quite low, since it does not have any aft opening and very few side openings. There are often further openings along the ship sides, which can total up to 10% of the ship sides. On the generic ship, the side openings for closed ro-ro spaces are very limited, but it was estimated that 80% of the few side openings would be closed, resulting in a 50% failure reduction. On the other hand, closed ro-ro spaces on the generic *Cargo* and *Ferry RoPax* ships have aft openings, which significantly increases the probability of fire spread through it. This probability was calculated based on estimations of the probability that a fire would occur in the first line of trucks (24 m) of the ro-ro space in front of the weather deck, based on the general arrangements of the generic ships. This figure was assumed to apply in case of successful suppression of the fire, while the probability of a fire occurring in one of the first two rows of trucks was used in case of unsuccessful suppression. Since the closed ro-ro space in front of the weather deck is quite small on the

Cargo RoPax, the proportion of the weather deck close to the opening is very large. A low probability for fire spread through potential openings distributed in the space sides was added for the rest of the space, based on the probability for flame spread through openings on the closed ro-ro space on the *Standard RoPax*. Based on the general arrangements of the generic ships, the probability in case of a suppressed fire was thereby calculated to 2220% higher for *Cargo RoPax* and 1000% higher for *Ferry RoPax* than for *Standard RoPax*. In case of an unsuppressed fire the probabilities were calculated to 155% higher for *Cargo RoPax* and 344% higher for *Ferry RoPax* than for *Standard RoPax*.

Flame spread through **Doors open** to the accommodation and other parts of the ship was estimated based on the number of doors that are commonly used in the closed ro-ro spaces. On *Ferry RoPax* ships, there are significantly more doors to each closed ro-ro space, to facilitate for the large number of passengers. The difference was estimated to 150% in comparison to *Standard RoPax* ship. *Cargo RoPax* ships on the other hand have significantly less doors to the closed ro-ro spaces, since the cargo mainly consists of large cargo (trucks) with a very limited number of passengers (truck drivers). The potential for flame spread through such openings was therefore estimated to 30% for *Cargo RoPax* compared to *Standard RoPax*. Based on the same reasoning, the same probabilities were assigned to smoke spread through **Doors open** to the accommodation and other parts of the ship.

With regard to heat spread due to **No fire insulation** in closed ro-ro spaces, this depends mainly on the availability of fire insulation and on what is above the space. A difference between the closed ro-ro spaces on the different types of ships is that *Cargo RoPax* has relatively a larger area of closed ro-ro spaces under weather deck. The heat spread potential to weather deck was considered lower than to other ro-ro spaces thanks to convective cooling of the outdoor deck surface. Furthermore, the *Cargo RoPax* has a relatively larger area of closed ro-ro spaces under the accommodation part of the ship, towards which there is always A-60 insulation. This is not always the case between ro-ro spaces. The probability of containment failure due to heat spread was based on this input and by comparison of general arrangements of the different generic ships estimated to 75% for *Cargo RoPax* compared to the other ship types.

Heat spread due to **Failure of boundary cooling** was considered to be more complex when there is accommodation spaces above the closed ro-ro space than if there is a ro-ro space above (if needed with consideration to potential fire insulation provided). It was not considered always possible to activate the fixed water-extinguishing system in a ro-ro space above the space on fire. Furthermore, it was considered more difficult to provide boundary cooling in a closed or open ro-ro space above the space with the fire than on a weather deck (where there is likely no smoke accumulation). Based on comparisons of the different deck areas in the general arrangements of the generic ships, areas with fire insulation and the possibilities for boundary cooling, the probability of containment failure due to failure of boundary cooling was estimated to 150% for *Ferry RoPax* and 70% for *Cargo RoPax* compared to *Standard RoPax*.

Failure of navigation in a way to avoid effects on evacuation and spread to accommodations was estimated to be much more difficult on *Standard* and *Ferry RoPax* ships primarily based on the number of passengers accommodated on these ships and on the design of openings for closed ro-ro spaces. Looking into the specifics of the generic ship general arrangements, the *Ferry RoPax* ship has a larger accommodation area where passengers could be mustered safely but at the same time the LSA embarkation areas are unfortunately placed by ro-ro space end openings and there is a large number of passengers to be evacuated if necessary. The *Standard RoPax* ship has a lower number of passengers but a smaller accommodation area for mustering the passengers. The *Cargo RoPax* ship has a relatively low number of passengers and a relatively simple design, which would make it easier to navigate in order to avoid smoke spread through accommodation or during evacuation. In all, the probability of containment failure due to failure of navigation in a way to avoid effects on evacuation and spread to accommodations was estimated the same for *Ferry* and *Standard RoPax* ships, but in comparison about 25% for *Cargo RoPax*.

The failure of containment due to smoke **Spread through openings** for closed ro-ro spaces on a *Standard RoPax* ship is quite low, since it does not have any aft opening and very few side openings. There are often further openings along the ship sides, which can total up to 10% of the ship sides. On the generic ship, the side openings for closed ro-ro spaces are very limited, but it was estimated that 80% of the few side openings would be closed, resulting in a 50% failure reduction. On the other hand, some of the closed ro-ro spaces on the generic *Cargo* and *Ferry RoPax* ships have aft openings, which significantly increases the probability

of smoke spread. Considering the small size of the closed ro-ro space with an aft opening on the *Cargo RoPax*, smoke spread was always assumed to occur in case of fire here. On the *Ferry RoPax*, smoke spread from the aft opening of the closed ro-ro space was assumed in case of fire in the first rows of trucks (24 m => 17%) if the fire is suppressed and in case of fire in one of the first two rows of trucks (48 m => 34%) if the fire is unsuppressed. In case of fire in the rest of the space (83% and 66%), an average of the probability for failure due to smoke spread through an open and a closed ro-ro space on the *Standard RoPax* was used to represent the potential for loss of containment due to smoke spread from a partially open closed ro-ro space, i.e. with an aft opening. Based on the general arrangements of the generic ships, the probability in case of a suppressed fire was thereby calculated to 293% higher for *Cargo RoPax* and 350% higher for *Ferry RoPax* than for *Standard RoPax*. In case of an unsuppressed fire the probabilities were calculated to 205% higher for *Cargo RoPax* and 244% higher for *Ferry RoPax* than for *Standard RoPax*.

Internal smoke spread due to **Failure of the ventilation system** to create an under pressure was considered very difficult for both *Ferry* and *Standard RoPax* ships, since the ventilation systems for these ships can be quite complicated and due to the many doors to the ro-ro spaces. The probability of failure for *Standard RoPax* in case of suppression failure was above estimated to 96.7%, which leaves little room for higher failure rates, but yet it was considered even more difficult on a *Ferry RoPax* than on a *Standard RoPax* ship. Probabilities close to zero and close to 100 are difficult to estimate and comprehend, but the assumption was made that the probability of containment failure due to failure of the ventilation system was 3% higher for *Ferry RoPax* than for *Standard RoPax*, resulting in a close to 100% failure rate for *Ferry RoPax* in case of suppression failure. For *Cargo RoPax*, however, there are often fewer ro-ro spaces and the ventilation systems are less complex. There are also significantly fewer doors and stairways connecting the closed ro-ro spaces, making it easier in general to foresee and manage smoke spread to the accommodation by the ventilation system. The probability of containment failure due to failure of the ventilation system for *Cargo RoPax* was estimated to about two thirds (65%) compared the that of *Standard RoPax*.

For weather deck containment failure, all the three bottom nodes of the fault were identified to be affected by the ship type. The estimated differences depending on the ship type for weather deck are presented in Table 21 and elaborated below.

Table 21: Differences in containment failure probabilities (bottom nodes) for weather deck spaces depending on ship type (relative to *Standard RoPax*)

<i>Ro-ro space</i>	<i>Affected nodes</i>	<i>Cargo</i>	<i>Ferry</i>	<i>Standard</i>
Weather deck	Failure of fire containment - Flame spread	70%	110%	100%
	Failure of fire containment - Heat spread	70%	110%	100%
	Failure of smoke containment - Smoke spread	90%	50%	100%

Failure of weather deck fire containment due to **Flame spread** was considered about equally likely on a *Ferry RoPax* as on a *Standard RoPax*. The factors considered were primarily the proximity to and the type of space in front of and above (slightly forward of) the weather deck, which for *Ferry* and *Standard RoPax* are a closed or open ro-ro space or an accommodation space in front of the weather decks as well as weather deck or accommodation space above (slightly forward of) the weather decks. On the *Ferry RoPax* the weather deck is slightly smaller than on the *Standard RoPax*, and therefore a slightly larger proportion of the *Ferry RoPax* weather deck was considered close to the spaces in front of and above (slightly forward of) the weather deck. The probability of failure was therefore estimated slightly larger for this type of ship (110% compared to *Standard RoPax*). The weather deck on the generic *Cargo RoPax* ship is larger than those on *Ferry* and *Standard RoPax* ships, and based on comparison of general arrangements of the different generic ships the probability of weather deck containment failure due to flame spread was estimated to 70% for *Cargo RoPax* compared to that of *Standard RoPax*. The same reasoning (proximity to spaces to which the fire will likely spread) was used for estimating the differences between ship types for the **Heat spread** node. For the **Smoke spread** node it was although considered that the large accommodation area on the *Ferry RoPax* will alleviate finding a safe place onboard. Considering that the accommodation space is about twice as large as that on the generic *Standard RoPax* ship, the probability of weather deck containment failure for

Ferry RoPax was estimated to about 50% compared to that of *Standard RoPax*. This estimation was considered to be quite uncertain by the participants, who yet agreed on the estimation. For the *Cargo RoPax* the differences compared to *Standard RoPax* were considered smaller. It was considered slightly less likely with a smoke spread related failure on a *Cargo RoPax* ship based on that there are less passengers on *Cargo RoPax* ships, even if the accommodation area is slightly smaller. The probability of weather deck containment failure due to smoke spread was estimated to 90% for *Cargo RoPax* compared to that of *Standard RoPax*.

9.3.3.3 Fire containment failure quantification for existing ships

No differences in fire containment failure were identified depending on whether the ship is a newbuilding or an existing ship.

9.4 Evacuation / Fire integrity of LSAs risk model

9.4.1 Determination of safety distances between openings and LSAs

In order to allow safe abandonment of the ship in case of fire, the LSAs onboard must stay available and usable.

SOLAS regulation II-2/20.3.1.5 provides a requirements stating that “permanent openings in the side plating, the ends or deckhead of the space shall be so situated that a fire in the cargo space does not endanger stowage areas and embarkation stations for survival craft [...]”.

However, this regulation is open for different interpretations as neither detailed requirements nor guidelines are available to ensure that the requirements are met. There is neither any literature defining a safe distance between openings and LSAs.

In order to determine a safe distance, or “optimal” distance as referred in this study (an optimal minimum distance to keep LSAs available and usable), an investigation has been performed using numerical (CFD) simulations and analytical calculations. The numerical simulations were used to evaluate side openings and analytical calculations was used to evaluate openings in the aft of a ship. The main results of these analyses were incident radiant heat fluxes from flames exiting from openings for ro-ro spaces where a fire is developing. These results were used to determine an optimal distance between openings and LSAs.

In the second part of this section, a safety distance was developed, with consideration to the fire integrity of LSAs and also taking into account the impact of smoke on LSAs.

9.4.1.1 Safety distance for exposure to radiant heat flux

9.4.1.1.1 Criteria for exposure to radiant heat flux

A set of new criteria for a safe distance between ro-ro space openings and the fire resistance of LSAs was developed in the current study. Reference was initially made to the fire resistance requirements for LSAs presented in section 7.4. However, these requirements were not considered applicable in the present study. They are based on fire tests during which the material sample is exposed to an incident radiant heat flux of 50 kW/m² and subsequently compared against the acceptance criterion that the material should not ignite within the first 40 seconds of the test, as detailed in MSC/Circ.1006 (IMO, 2001). Time to ignition at 50 kW/m² at least gives an idea of the ignitability. A high performing polymer is required to meet this requirements and insufficient materials are hence excluded by this test. However, in the context of the current study and for practical reasons, the incident radiant heat flux of 50 kW/m² and the corresponding acceptance criterion was deemed unsuitable, since it mainly assesses the time to ignition during direct exposure to flames (high incident flux). It was therefore necessary to establish a set of new criteria applicable for critical heat exposure at a larger distance in this study. On a foundational level, materials exposed to radiant heat will ignite when the radiant heat flux exceeds a critical value (SFPE, 2002). The critical heat flux is defined as either the minimum radiant heat flux required to ignite a material, or the maximum radiant heat flux which

will not cause ignition during a period of 60 minutes⁵. The SFPE Handbook of Fire Protection Engineering provides a table showing a list of typical materials and their critical radiant heat flux shows an extract for a group of materials that can be used for LSAs.

Table 22: Group of materials used in LSAs and their critical heat flux, from (SFPE, 2002)

Material	Critical Heat Flux (kW/m ²)
Synthetic materials	10 - 16
Halogenated materials	10 - 50
Composite and Fiberglass-Reinforced materials	10 - 40
Foams (Wall ceiling insulation materials, etc.)	10 - 40
Materials with Fiberweb, Net-Like and multiplex structures	8 - 18

In order to keep LSAs available and usable, a conservative decision was made to determine the criterion regarding the maximum radiant heat flux to 5.0 kW/m². The chosen criterion was based on the low value in the range of critical heat flux for the materials presented in the Table 23, 10 kW/m², divided by a safety factor of 2.

It should be noted that some LSAs (e.g. lifeboats) include an embarkation station for passengers. For such LSAs, the previous criterion cannot be used. A radiant heat flux higher than 2.5 kW/m² is critical and harmful for person without thermal protection (SFPE, 2002) and is a life-safety criterion stated in MSC.1/Circ.1552 (amendment to MSC/Circ.1002). Hence, two criteria based on radiant heat flux exposure were proposed, as presented in Table 23.

Table 23: Radiant heat flux safety criteria for LSAs

Type of LSAs*	Maximal incident radiant heat flux allowed at the LSA
Presence of passengers (Lifeboat, launching appliances, embarkation stations, MES)	2.5 kW/m ²
No passenger (Life raft)	5.0 kW/m ²

*In the present study, only the survival craft LSAs were considered.

To determine safety distances between openings and LSAs, a parametric study was performed. The incident radiant heat flux depends of the flame emissive power⁶ (depending on the fuel type, flame shape, etc.) and the distance between the fire and the target. The critical incident radiant heat flux corresponds to the criteria in the Table 23 and simulations were performed to determine the flame emissive power, and finally the safety distances.

⁵ As mentioned previously, the critical heat flux criterion was based on the radiant heat flux required to ignite a typical LSA material. It is worth noting that after a long exposure of heat radiation, the tested material may degrade to a certain extent even if there is no ignition.

⁶ Emissive power or emittance is the amount of energy emitted by a body, for all possible wavelengths.

9.4.1.1.2 Numerical simulations and analytical calculations

9.4.1.1.2.1 Radiant heat flux from aft openings or weather deck: Analytical calculations

A weather deck fire could expose adjacent LSAs and so could the large ro-ro space aft openings. Aft openings are present on all of the selected generic ships, in the transition of closed or open ro-ro space to weather deck.

A fire developing in the aft part of the ro-ro space or on the weather deck would imply intense heat radiation in the aft of the ship. Depending on the extent of the fire scenario, flames may impact LSAs stowed in adjacent areas, e.g. on the deck right in front of/above the weather deck. A fire scenario exposing LSAs to heat radiation from flames can be represented as in Figure 15.

- $H_{\text{visible flame}}$ = Height of the flame visible by the LSA
- H_{deck} = Height of the top deck
- H_{cargo} = Height of the cargo
- H_{wheels} = Height of the wheels of the cargo
- H_{flame} = Height total of the flame

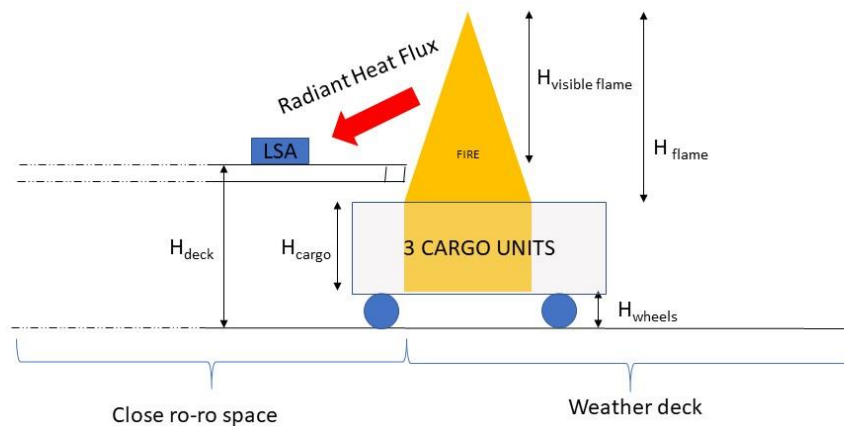

Figure 15: Scientific representation of a fire on a weather deck and its radiant heat exposure on LSAs.

In order to estimate the radiant heat flux exposing LSAs, an analytical calculation was made. This analytical approach was based on the solid flame radiation model which approximates a flame as radiant heat emitted from a wall. The geometry of the wall (base and height) and its equivalent flame emissive power were based on the burning material (mass burning rate of fuel, effective heat of combustion of the fuel and fuel area). A short presentation of the solid flame model is given below, while further explanation of this model are available in the SFPE Handbook (SFPE, 2002).

In the current case, the fire was assumed to be represented by three half cargo units burning side by side.

The incident radiant heat flux towards a target is a function of the emissive power of the flame and the view factor between the target and the flame, as described by Equation 1:

Equation 1:
$$Q_{inc} = E \times F_{flame \rightarrow target}$$

where:

Q_{inc} is the incident radiant heat flux (kW/m²);

E is the average emissive power of the flame; and

$F_{flame \rightarrow target}$ is the view factor between the target and the flame.

The main approximation of this model is that consider that the flames are equivalent between a solid material fire and a liquid pool fire. This approximation thus allows the use of an equivalent fire diameter, defined in Equation 3. Based on this assumption, the average emissive power of the flame can be determined by Equation 2 (Beyler & Shokri, 1989).

Equation 2:
$$E = 58 \times (10^{-0.00823 \times D})$$

where D is the equivalent diameter (m) of the fire.

This equivalent diameter was defined by (Heskestad, 1997) as in Equation 3 (for this application):

Equation 3:
$$D = HRR / (4 \times 320 \times H_{cargo})$$

Heskestad defined this diameter in order to take into account the energy released by an in depth burning rack storage.

For Equation 1 it is also necessary to define of the view factor between the flame and the target. This view factor is given by Equation 4.

Equation 4:
$$F_{flame \rightarrow target} = \frac{1}{2\pi} \left[\frac{X}{\sqrt{1+X^2}} \arctan\left(\frac{Y}{\sqrt{1+X^2}}\right) + \frac{Y}{\sqrt{1+Y^2}} \arctan\left(\frac{X}{\sqrt{1+Y^2}}\right) \right]$$

where:

$$X = \frac{H_{visible\ flame}}{distance\ flame-target} \text{ and } Y = \frac{width\ of\ the\ fire\ wall}{distance\ flame-target}$$

An unknown parameter in this equation is the flame height (the visible part of the flame, which is the flame height minus the clearance between the top of the cargo units and the floor of the deck above), which is deduced from Equation 5 (Heskestad, Luminous heights of turbulent diffusion flames, 1983) and Equation 6:

Equation 5:
$$H_f = 0.235 \times HRR^{\frac{2}{5}} - 1.02 \times D$$

where, HRR is the heat release rate from the fire and is defined as:

Equation 6:
$$HRR = \dot{m}'' \times \Delta H_c \times A$$

where

\dot{m}'' is the mass burning rate of fuel per unit surface area (kg/m².s);

ΔH_c is the effective heat of combustion of fuel (kJ/Kg);

A is the area of the fire.

In the current case, the area of the fire was estimated to 112 m² (external areas of three half cargo units), giving a 9.1 m diameter of an equivalent cylinder defined by the Equation 3.

The considered scenario was a fire of cargo units situated in the worst position, on the edge between the weather deck and the closed ro-ro space. In 1997, Arvidson estimated the typical cargo of a "freight truck" by using piles of cardboard boxes, of which some were empty, and some contained polystyrene cups, tarpaulin and tailgates (Arvidson, 1997). However, the solid flame model cannot be used for a multi-material fire and instead, based on the data from Arvidson (Arvidson, 1997), an average heat of combustion and an average mass burning rate were determined, as presented in Table 24.

Table 24: Thermo-physical data used as input for the solid flame model (Arvidson, 1997)

Item	Weight [kg]	Heat of combustion [MJ/kg]	Mass burning rate [g/m ² ·s]
Polystyrene cups	1620	27	36
Cardboard boxes	4032	15.6	26
Tarpaulin	984	20.6	14
Tailgates	852	14	6
Equivalent material	7488	19.95	15.61

Based on the data from the Table 24 and Equation 6, the heat release rate of the cargo fire was calculated to 35 MW. Furthermore, Equation 4 gave a flame height (H_{flame} in Figure 15) of around 6.2 meters and Equation 2 gave a flame emissive power of 48.79 kW/m².

For the Ferry RoPax, the different heights noted in Figure 15 were determined to:

- $H_{\text{deck}} = 5.5$ meters
- $H_{\text{cargo}} = 3.0$ meters
- $H_{\text{wheels}} = 1.2$ meters.

Based on the above heights and as illustrated in Figure 15, the height of the flame visible to the LSAs was calculated to $H_{\text{visible flame}} = 4.8$ meters.

Determination of the safety distances based on the criteria given in Table 23 was based on View Factor Calculation. This calculation is a methodology used to determine the relationship of the distance between flame and target (LSAs) and the incident radiant heat flux.

The resulting incident radiant heat flux is then calculated with the View Factor Calculation (Equation 4) for the generic *Ferry RoPax* ship is shown in Figure 16.

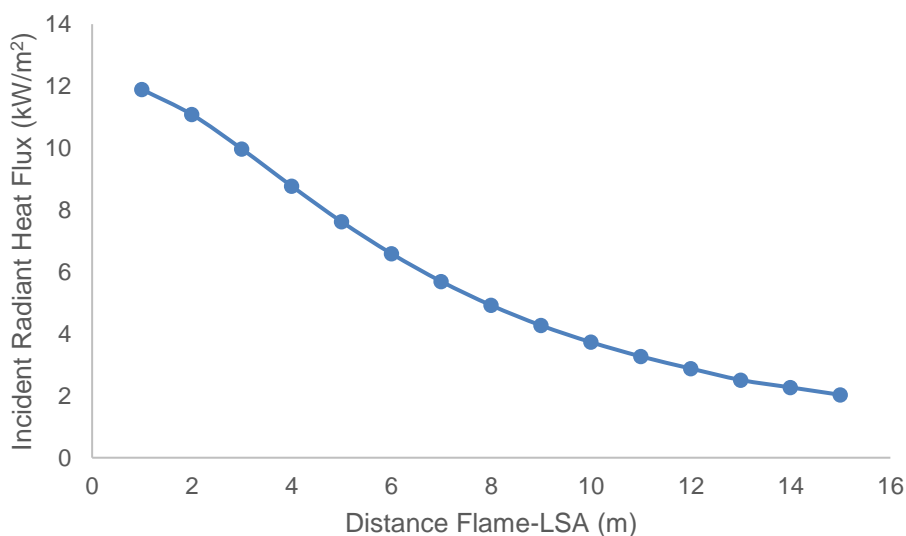

Figure 16: Incident radiant heat flux as a function of the distance flame-LSA for the case of the *Ferry RoPax*.

From Figure 16, the safety distances between the edge of the flame (edge of the top deck) and LSAs was determined, as summarized in Table 25.

Table 25: Safety distances for LSA on the top deck of the *Standard RoPax* ship.

Type of LSAs	Maximal radiant heat flux allowed at the LSA	Safety distance
Presence of passengers (Lifeboat, embarkation stations and MES)	2.5 kW/m ²	13m
No passenger (Life raft stowage areas)	5.0 kW/m ²	8 m

It should be noted that these analytical calculations must be performed for each case. The model is dependent on the geometry of the ro-ro space (receiving the cargo and where the LSAs are situated). However, for the case where H_{deck} equals 5.5 m, the safety distances presented in Table 25 can be used.

9.4.1.1.2.2 Radiant heat flux from side openings: Numerical simulations

To find the shape and thermal characteristics of flames exiting side openings of an open ro-ro space, numerical simulations were performed. They were based on the simulations performed in the first part of the study to evaluate detection (EMSA, 2018), using Fire Dynamics Simulator (FDS). FDS is a computational fluid dynamics (CFD) model of fire-driven flow and solves numerically a form of the Navier-Stokes equations appropriate for low-speed ($Ma < 0.3$), thermally-driven flow with an emphasis on smoke and heat transport from fire.

In the simulations, the ro-ro space on Deck 4 of the *Standard RoPax* was used as basis. The geometry of the ro-ro space was modelled according to the General Arrangement of the ship, but the length of the space was reduced to reduce the time required for the simulations. The size and positions of the openings (openings sized 3x2 m in clusters of four) were kept identical as in the simulations carried out in Part 1 of the FIRESAFE II study. An illustration of the model used is presented in Figure 17.

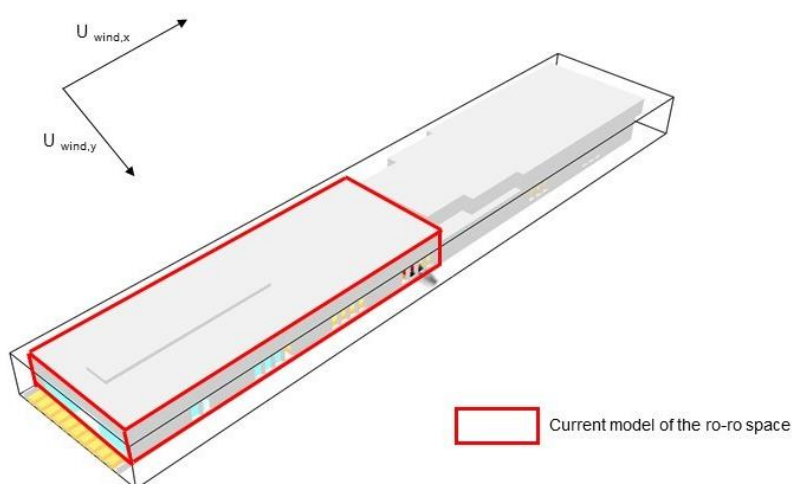

Figure 17: View of the ro-ro space used for the simulations.

Furthermore, other simulation parameters were kept identical, including:

- Cell size: 20cm x 20 cm x 20cm for the flaming zone, and 40 cm x 40 cm x 40 cm elsewhere
- Soot yield: 0.06 g/g

- CO yield: 0.1 g/g
- Materials for the ceiling and floor: unprotected steel
- A class division bulkheads in accordance with the documents provided by Stena (Mineral wool insulated steel according to SOLAS standards)
- Deck load configuration: fully loaded with cars and trucks (yellow and blue, respectively in Figure 17)
- Deck is naturally ventilated (i.e. no mechanical ventilation system)

It was decided to use a fast fire growth rate (instead of medium and slow fire growth rate used in the detection simulations). Furthermore, a higher heat release rate and wind velocities (in two directions as shown in Figure 17) were used than the values used in the detection simulations (EMSA, 2018), to account for a worst case scenario with regard to heat exposure. Moreover, the simulated fire duration was 20 minutes in order to reach a fully developed fire.

Table 26 presents the different heat release rate and wind velocities used as well as the wind directions used in the simulations.

Table 26: Input values used in the fire scenarios simulated to evaluate radiative heat flux through ro-ro space side openings.

Total Heat Release Rate (MW)	Exterior Wind velocity in the x axis (m.s ⁻¹)	Exterior Wind velocity in the y axis (m.s ⁻¹)
2, 6, 10, 25, 50	2, 5, 7	2, 5, 7

The advantage of using numerical simulations is that the output directly provides the incident radiant heat flux at specified locations, by use of virtual sensors. A grid of sensors was positioned in the model but in Figure 18, only the sensors used to determine the safety distance are shown.

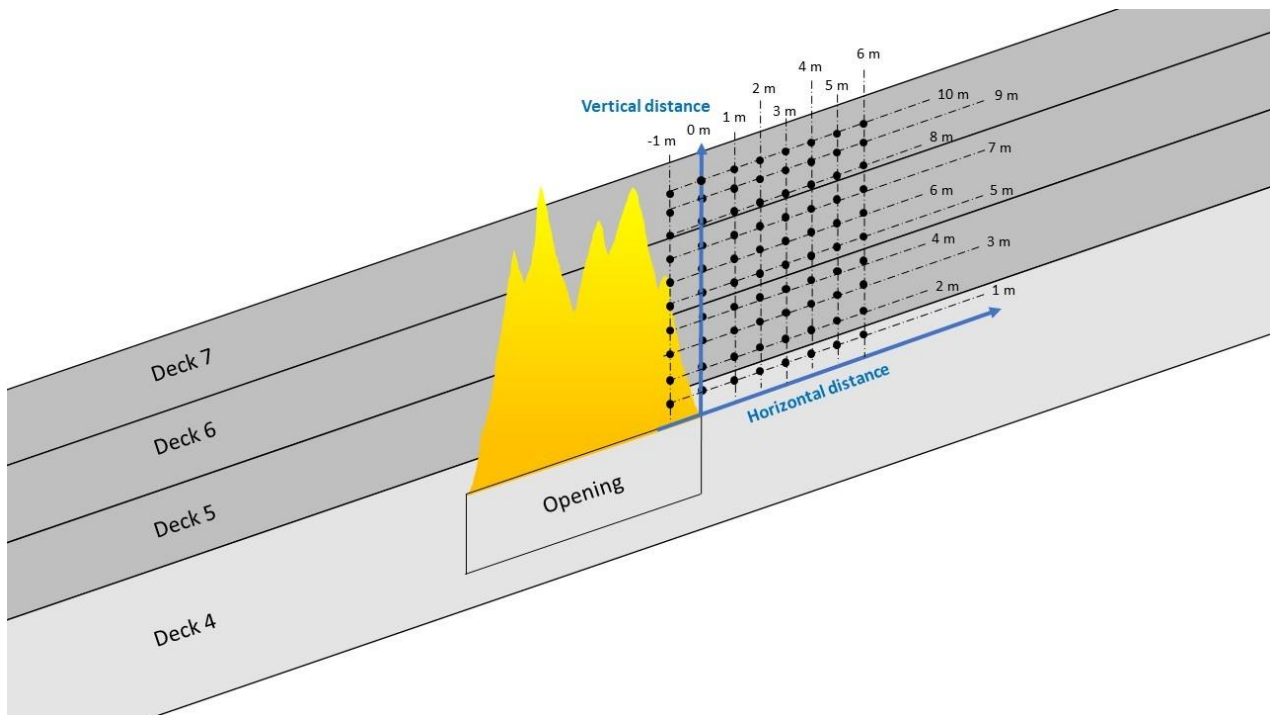

Figure 18: Position of the radiant heat flux sensors close to openings.

The scenario giving the heat release rate and wind velocity naturally resulted in the highest radiant heat flux close to the openings. The incident radiant heat flux for each sensor is presented in Figure 19.

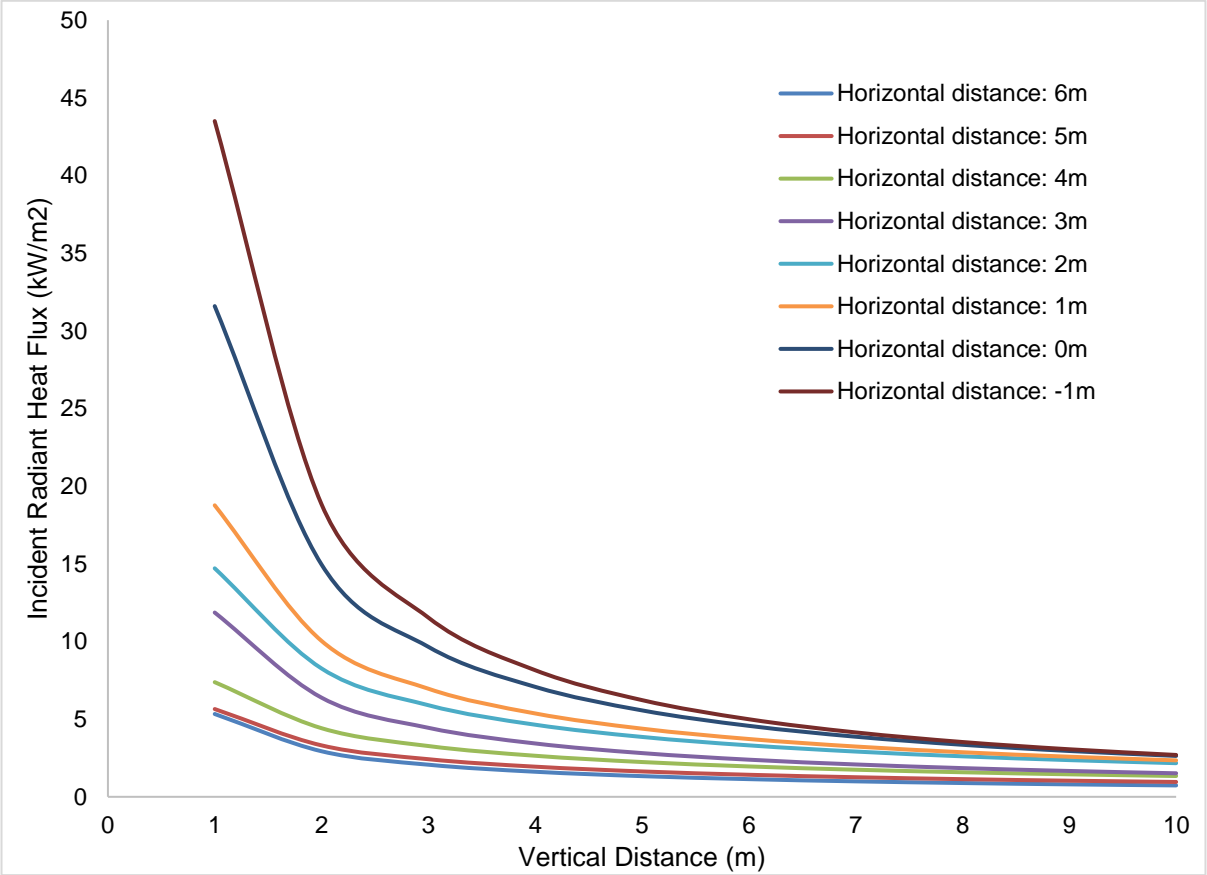

Figure 19: Maximal incident radiant heat fluxes received by FDS sensors for the worst-case scenario

Using the criteria developed above (Table 23), Figure 20 presents the required minimum distance between the edge of the openings and the position of LSAs.

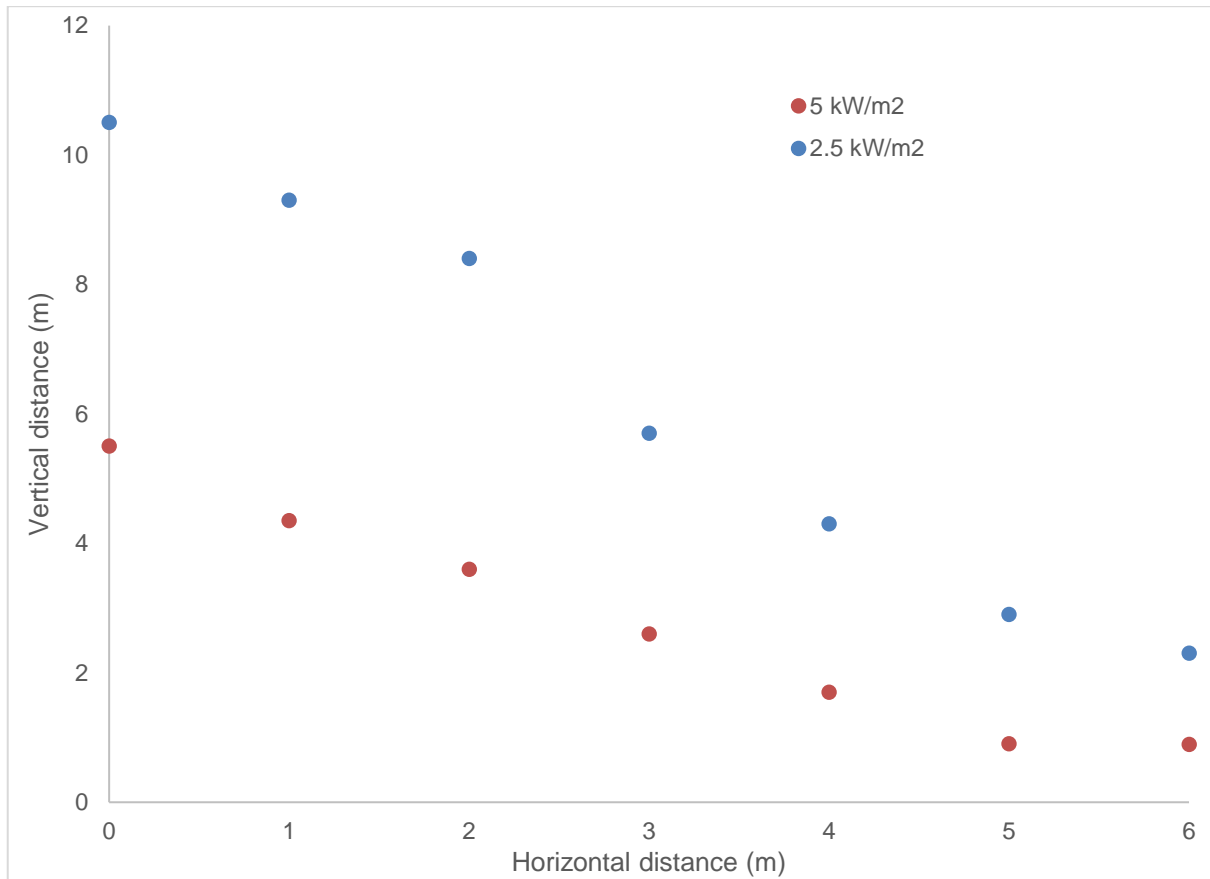

Figure 20: Minimal distance based on radiative heat flux criteria of 5.0 and 2.5 kW/m².

Based on the results in Figure 20, it was possible to determine zones on the generic RoPax ships where LSAs need to be excluded around openings. For LSAs without presence of passenger (e.g. life rafts launched directly into the water), the exclusion zone (exclusion zone 1) extends to 6 meters around the opening. For LSAs with the presence of passenger (e.g. life boats with embarked passengers), the exclusion zone (exclusion zone 2) includes the full vertical side of the ship, 6 m forward and aft of the (width of the) opening. These exclusion zones are illustrated in Figure 21 and are collectively below referred to as a “critical zone” with regard to openings and evacuation safety.

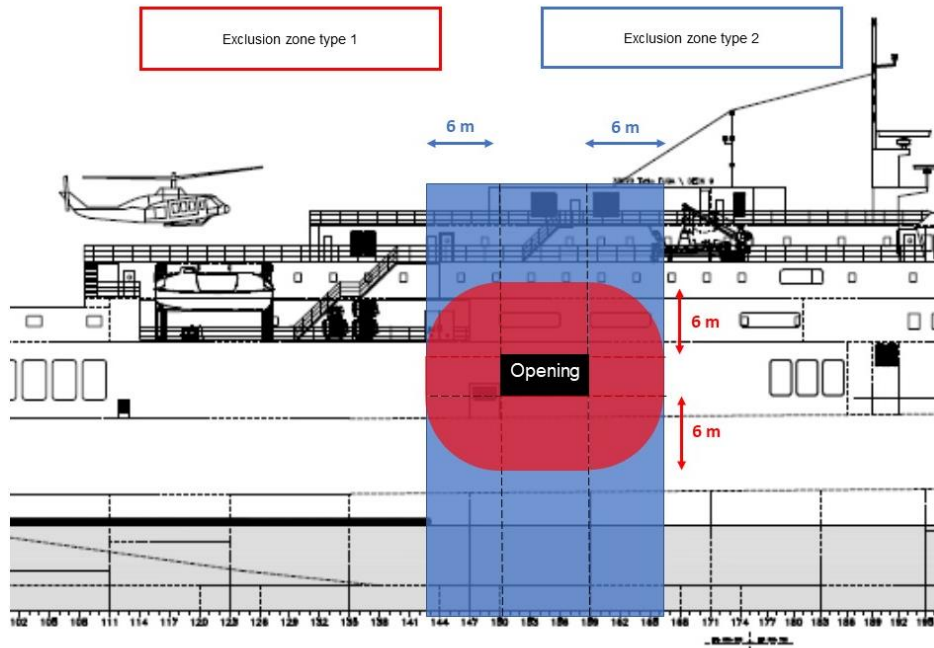

Figure 21: Zones in which LSAs should be excluded, where exclusion zone type 1 (red) applies to LSAs which may involve passengers and exclusion zone type 2 (blue) applies to LSAs which do not involve passengers (e.g. life rafts launched directly into the water).

9.4.1.2 Safety distance in case of smoke exposure

To determine a safety distance between an opening and LSAs with regard to smoke exposure, analytical calculations were carried out. As a first approximation, the smoke plume from an opening can be approximated as a plume coming from a chimney, without influence from wind. When the safety target is near the source (present case), the radius (R) of the plume is dominated by its momentum (buoyancy effect) and then only dependent of its elevation (z) (Hanna, Briggs, & Hosker, 1982), in accordance with Equation 6 and illustrated in Figure 22:

Equation 6:
$$R(z) = R(z_0) + \Delta R(z) = R(z_0) + (0.16 \times z),$$

where

z is the elevation of the smoke plume;

R is the radius of the smoke plume; and

ΔR is the variation of the radius of the smoke plume.

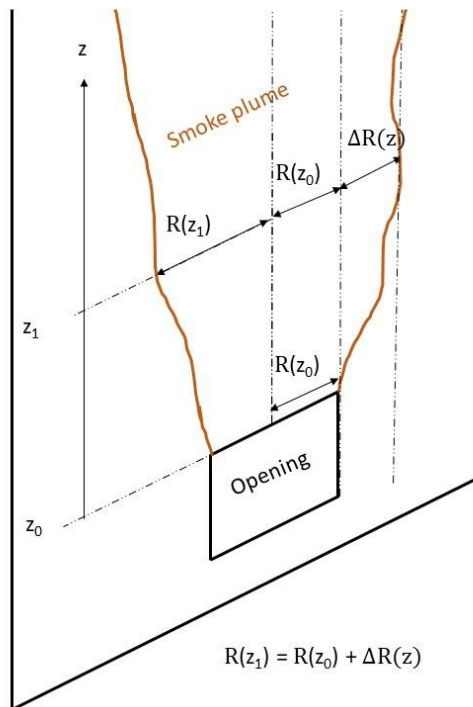

Figure 22: Illustration of the smoke plume from an opening

In a worst-case scenario, the maximal elevation of the plume (interacting with LSAs) is the maximum height from openings to the LSAs on the considered ship. The maximal elevation of the smoke plume was measured based on the general arrangements of the different types of RoPax ships and is presented in Table 27.

Table 27: Maximal variation of plume radius depending on RoPax ship type

Type of RoPax	Maximal elevation (m)	Maximal variation of the smoke plume radius (m)
Standard RoPax	15	2.4
Cargo RoPax	16.96	2.7
Ferry RoPax	23.6	3.7

As smoke and its content of toxic gases are harmful to passengers, the criterion was assumed that LSAs should not be allowed within the smoke plume.

Using a safety factor of 2, the exclusion zone for smoke exposure (Exclusion zone type 3) will include an area extending from the bottom of the opening and 3.8 m forward and aft of the opening. However, this exclusion zone, exclusion zone 3, is hence included in exclusion zone 2 and was not further considered.

It should be noted that smoke may spread with the wind and cause unsafe conditions also beyond the critical zone (exclusion zone 1, 2 and 3), as considered in 9.4.3.3.1. However, within the critical zone (exclusion zone 1, 2 and 3), smoke or flame spread was always assumed to cause unsafe conditions for evacuation, while for example wind conditions will affect the safety of evacuation outside the critical zone.

9.4.1.4 Summary of the safety distance between openings and LSAs

The safety distance between openings and LSAs, considering exposure to radiant heat and smoke as well as different types of LSAs (involving passengers or not) are presented in Table 28.

Table 28: Required safety distances from ro-ro space side openings to LSAs

Opening	Exposure	Type of LSAs	Safety distance from opening (m)
Side opening	Radiant heat flux	With passengers	Horizontal: 6 m Vertical: Height of the ship
	Radiant heat flux	Not with passengers	6 m
	Smoke	All types	Horizontal: 6 m Vertical: Height of the ship
Aft opening ($H_{\text{deck}} = 5.5 \text{ m}$)	Radiant heat flux	With passengers	13 m
	Radiant heat flux	Not with passengers	8 m

9.4.2 Ro-ro space openings and their distance to LSAs

The sides of some ro-ro spaces may have permanent openings. When a fire breaks out in the ro-ro space, flames may exit through such openings. It is essential that events of this character do not further complicate rescue or evacuation operations. This is enforced through SOLAS regulation II-2/20.3.1.5, which states that a fire in a cargo space should not endanger stowage areas and embarkation stations for survival craft such as life boats, life rafts and MES, as well as embarkation stations.

An important parameter to ensure the safety of evacuation operations is thus the distance between LSAs and ro-ro space openings. In this paragraph, those distances have been evaluated for each group of openings and LSAs, for all the types of generic RoPax ships examined in the study. Furthermore, critical openings within the above defined exclusion zones (summarized in Table 29) are highlighted.

9.4.2.1 Standard RoPax

9.4.2.1.1 Description of the locations of the openings

The starboard side view of the generic *Standard RoPax* ship is shown in Figure 23, including marked openings and LSAs.

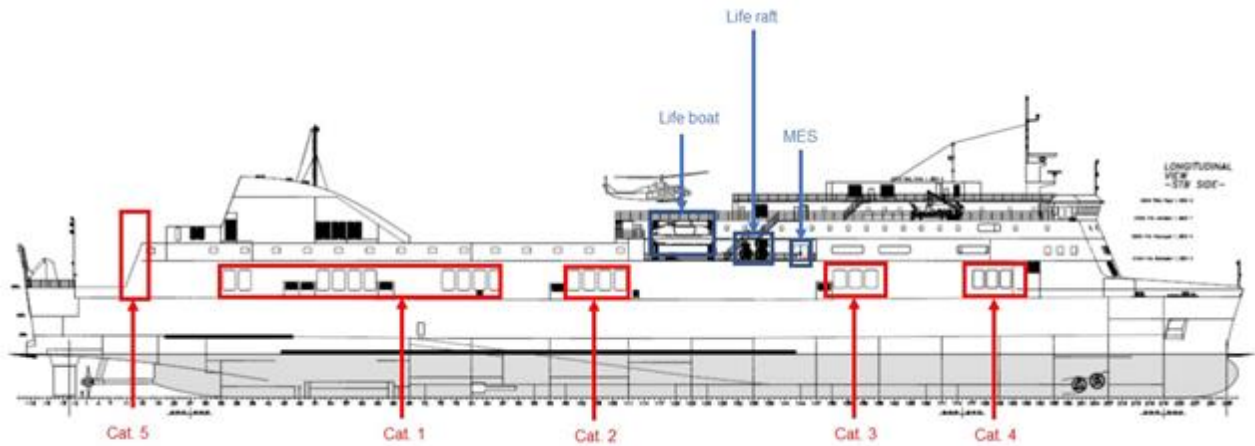

Figure 23: Starboard arrangement of openings for the *Standard RoPax* ship.

The openings on the *Standard RoPax* ship are all located on Deck 4. Considering the layout for this deck, the openings on the port side of the ship may be identified as seen in Figure 24.

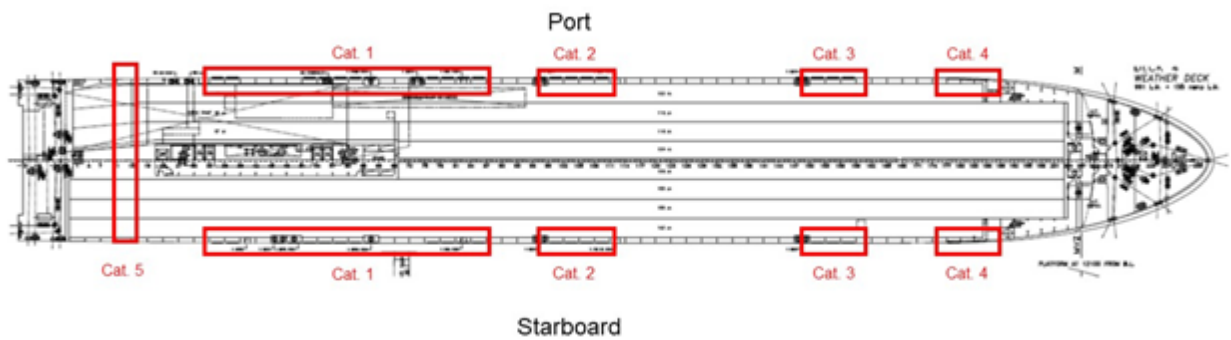

Figure 24: Openings of the *Standard RoPax* on deck 4, from above.

The aft opening, defined as Cat. 5, in Figure 23 and Figure 24 is illustrated in Figure 25.



Figure 25: Picture illustrating a part of the aft opening on the *Standard RoPax* selected.

9.4.2.1.2 Distance between openings and LSAs

Distances between LSAs and openings were measured according to Figure 26. It should be noted that this figure is simply an illustration (may be out of scale) of the distances. The horizontal (H) and vertical (V) distances were measured between the categorized opening and its nearest LSAs. The direct (D) distance was then obtained by $D = \sqrt{H^2 + V^2}$.

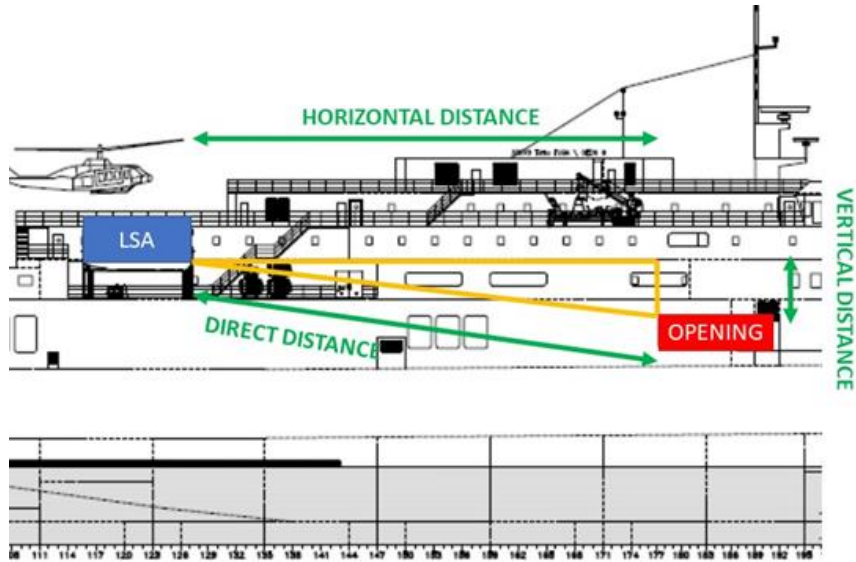

Figure 26 Principle for measuring the distances between openings and LSAs.

For aft openings, only the horizontal and vertical distances are given, since the direct distance cannot be calculated due to obstruction by the ship structure. In Table 29, the distances (horizontal, vertical and direct) between the identified openings and the LSAs are summarized.

Table 29: Measured distances between openings and LSAs on the *Standard RoPax* ship.

Opening Category	Distance to nearest life boat [m]	Distance to nearest life raft [m]	Distance to nearest MES [m]
Starboard and port sides			
1	$H = 22.6$	$H = 36.9$	$H = 45.2$
	$V = 3.8$	$V = 1.4$	$V = 1.4$
	$D = 22.9$	$D = 37.0$	$D = 45.2$
2	$H = 3.2$	$H = 17.5$	$H = 25.8$
	$V = 3.8$	$V = 1.4$	$V = 1.4$
	$D = 5.0$	$D = 17.6$	$D = 25.9$
3	$H = 14.7$	$H = 10.0$	$H = 4.0$
	$V = 3.8$	$V = 1.4$	$V = 1.4$
	$D = 15.2$	$D = 10.1$	$D = 4.2$
4	$H = 31.6$	$H = 31.5$	$H = 25.5$
	$V = 3.8$	$V = 1.4$	$V = 1.4$
	$D = 31.8$	$D = 31.6$	$D = 25.6$
Aft opening			
5	$H = 75.2$	$H = 89.2$	$H = 97.8$
	$V = 6.3$	$V = 6.1$	$V = 6.1$

From Table 29, two categories of openings are situated in the critical zone with regard to the safety distance between openings and LSAs:

- Opening category 2: less than 6 meters to the nearest Life Boat.
- Opening category 3: less than 6 meters to the nearest MES.

9.4.2.2 Cargo RoPax

9.4.2.2.1 Description of the locations of the openings

The general arrangement of the *Cargo RoPax* is presented in Figure 27 and indicates the openings for ro-ro spaces as well as LSAs. In this case, there is only one aft opening located on the main deck.

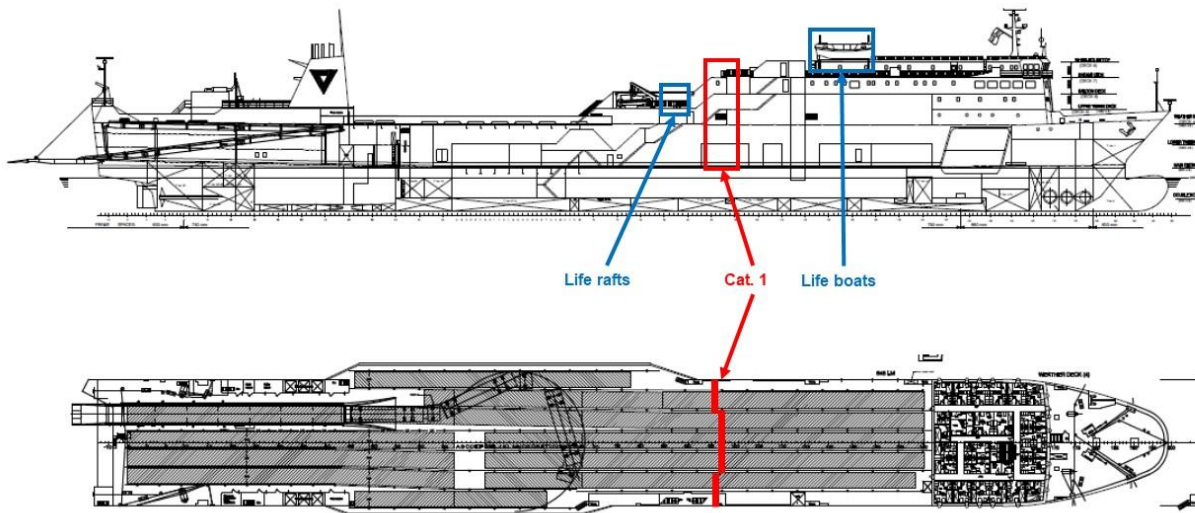

Figure 27: Starboard side and top view of the *Cargo RoPax* ship with marked openings and LSAs.

The actual aft opening of the *Cargo RoPax* is also shown in Figure 28.



Figure 28: Picture of the aft opening of the *Cargo RoPax*.

The location of LSAs on the port side of the ship side is slightly different from what is shown in Figure 28, as illustrated in Figure 29. Both the life raft and life boat are located on the bridge deck.

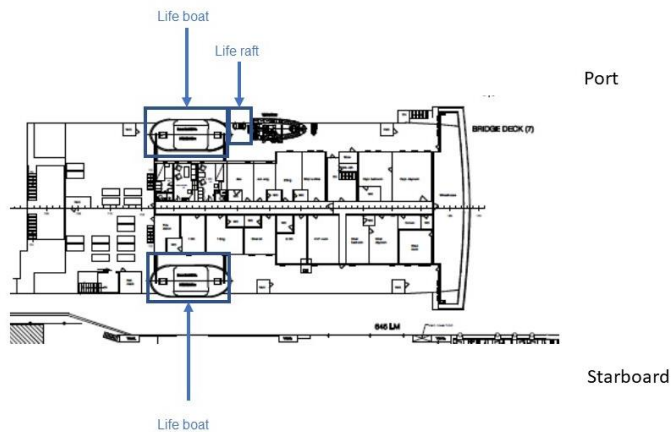

Figure 29: Top view of the bridge deck of the *Cargo RoPax*.

9.4.2.2.2 Distance between openings and LSAs

The distances (horizontal, vertical and direct) between the identified openings and the LSAs on the *Cargo RoPax* ship are summarized in Table 30.

Table 30: Measured distances between openings and LSAs on the *Cargo RoPax*

Opening Category	Distance to nearest life boat [m]	Distance to nearest life raft [m]
LSAs on starboard side		
1	$H = 15.4$	$H = 0$
	$V = 14.4$	$V = 14.2$
LSAs on port side		
1	$H = 15.4$	$H = 24.9$
	$V = 14.4$	$V = 14.2$

For the *Cargo RoPax*, all LSAs were considered safe with regard to the safety distances between the aft opening and LSAs.

9.4.2.3 Ferry RoPax

9.4.2.3.1 Description of the locations of the openings

The starboard side view of the *Ferry RoPax* ship may be seen in Figure 30 with the locations of openings (one aft opening) and LSAs marked.

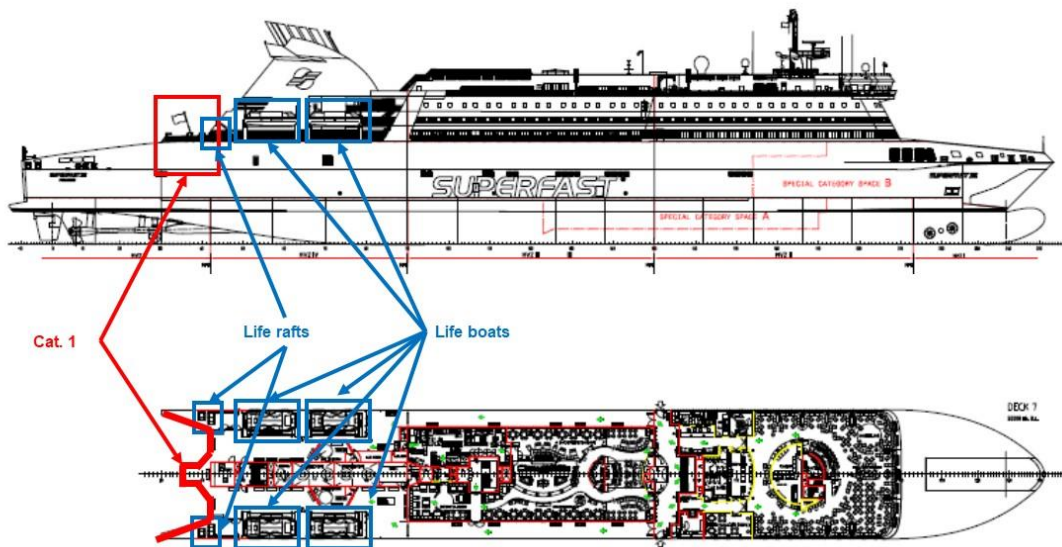

Figure 30 Starboard side and top view of the *Ferry RoPax* with marked openings and LSAs.

The *Ferry RoPax* has the same arrangement of LSAs on both sides of the ship. The aft opening on the *Ferry RoPax* ship is shown in Figure 31.



Figure 31: Picture of the aft openings on the *Ferry RoPax* ship.

9.4.2.3.2 Distance between openings and LSAs

The distances between openings and their closest LSAs are presented in Table 31.

Table 31: Measured distances between openings and LSAs on the *Ferry RoPax* ship.

Opening Category	Distance to nearest life boat [m]	Distance to nearest life raft [m]
Aft opening		
1	$H = 6.2$	$H = 0$
	$V = 5.5$	$V = 5.5$

For the *Ferry RoPax*, all the LSAs were considered unsafe, as their distances to the aft opening are smaller than the safety distance.

9.4.3 Evacuation failure model

Evacuation failure was defined as an event during which at least one LSA is rendered inoperable due to smoke, flames, or other modes of failure not related to fire. The latter includes failure due to adverse weather conditions, technical failure, and operational failure. These are henceforth encompassed in the definition “intrinsic failure of the LSA”. It should be noted that conduction of heat through the structure was not considered, since the structural fire integrity under evacuation routes and embarkation stations should be sufficiently thermally insulated in line with SOLAS II-2/9.

The event tree presented in Figure 32 was reported in (Vanem & Skjong, 2004) and applies to evacuation of RoPax ships both at sea and at shore, resulting in successful evacuation, unsuccessful evacuation or no evacuation (successful). This event tree was adapted in the current study to take into account both intrinsic failure of evacuation and evacuation impeded by fire. The reported probability for unsuccessful evacuation at sea, 36%, was assumed to represent intrinsic evacuation failure. Evacuation failure due to impact from the fire was added to this number, based on quantifications for each generic ship as elaborated below. It should be noted that this is considered conservative, as the quantification of the original evacuation model may already contain some events where LSAs are impacted by fires.

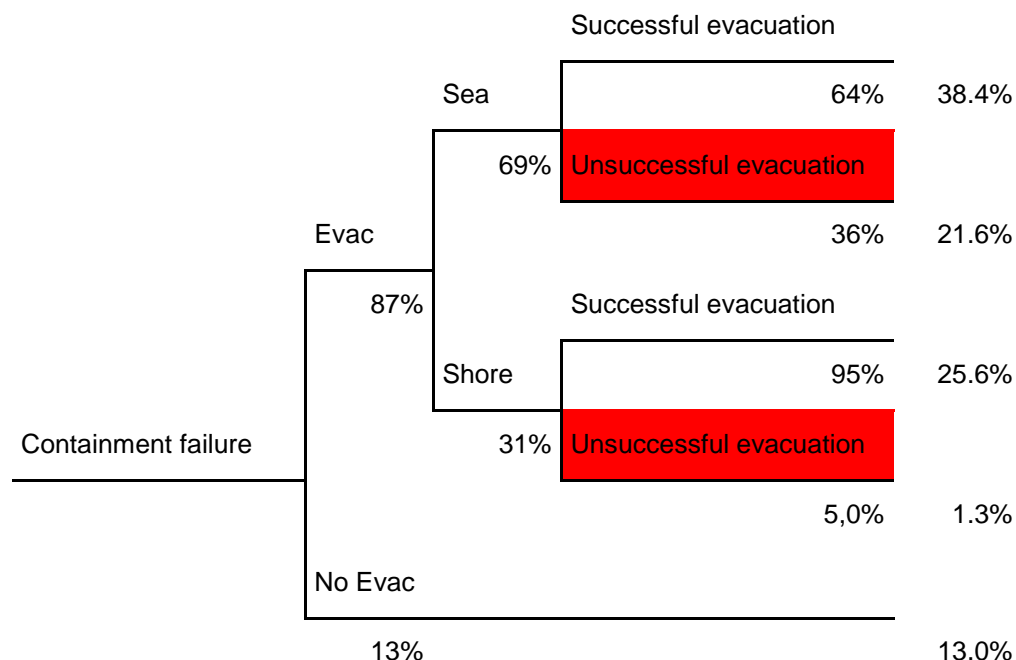

Figure 32: Evacuation model used to estimate the probability of evacuation failure in case of containment failure (Vanem & Skjong, 2004)

The evacuation model by (Vanem & Skjong, 2004) was utilized and added to each of the branches resulting in fire containment failure, where only the branch unsuccessful evacuation at sea was adapted in the current study. For the other nodes, the values presented in (Vanem & Skjong, 2004) for RoPax ships were utilized. The model was applied both in the context of evacuation at sea and at port, since failure of containment was assumed to impede evacuation routes. The value for unsuccessful evacuation at sea was calculated from the evacuation failure model, further described below, for the fire scenarios resulting in impacted evacuation, depending on the specific conditions of the selected generic ships and potential RCOs.

9.4.3.1 Failure modes

In the context of fire, an LSA is rendered inoperable when the radiative heat flux from flames causes it to deteriorate, e.g. melt or burn, or when conditions near the LSA are such that embarkation is associated with a high degree of danger, regardless of whether it is due to flames radiation or smoke.

In order to estimate the probability of evacuation failure it was first necessary to understand the causes that give rise to such an event and the affecting conditions. The probability of evacuation failure is principally dependent on whether the fire occurs on weather deck, in open ro-ro space, or in closed ro-ro space. Furthermore, if a scenario is considered to include flame and smoke spread through at least one of the openings, the probability of LSAs becoming inoperable may depend on:

- prevailing wind conditions;
- the fire location in the ro-ro space;
- the operational status of the fixed fire-extinguishing system; and
- the position of the LSAs relative to the openings and the fire.

The importance of each of the above factors is highly dependent on the specific ship examined, regardless of ship type. However, the three generic RoPax ships were examined as examples, defined above with respect to their associated susceptibility to evacuation failure (see section 9.4.1).

9.4.3.2 General model assumptions

Intrinsic failure of LSA was accounted for in the calculations for all the branches where evacuation was considered initiated.

For LSAs to be impacted by fire from a ro-ro space, there needs to be either smoke or flame spread from one or more of the openings. The probability for LSAs being impacted by heat or smoke is also dependent on the location of LSAs relative to the fire, size of the fire, and the wind direction. The probability for wind in a direction towards the LSAs was assumed to be 25 %.

The reasoning behind impacted evacuation due to endangering LSAs is briefly elaborated below, with starting point in the three types of ro-ro space. The developed criteria are then subsequently applied to each generic ship, to describe how effects on evacuation were estimated.

9.4.3.2.1 Fire in closed ro-ro space

Fires that occur in closed ro-ro spaces were not disregarded in this study. Side openings for such spaces are very limited but fire close to the aft opening may also impede evacuation. This scenario may occur on *Ferry RoPax*, as detailed in section 9.4.3.4.1. Furthermore, fire close to the closed ro-ro space aft opening on the *Cargo RoPax* may impede evacuation. However, in the latter case, the wind direction was considered to have an impact on whether evacuation is impacted, as detailed in 9.4.3.5.1. No other fires in closed ro-ro spaces were considered to cause evacuation failure due to LSA being impacted by smoke or flame radiations.

9.4.3.2.2 Fire on weather deck

Evacuation failure due to fire on weather deck was assumed to occur when either:

- Radiation from flames impacts LSAs, which occurs in case of fire within the critical distance (8 m) from LSAs, calculated in paragraph 9.4.1.1.2.1; or
- Smoke spreads from the fire in a wind direction towards LSAs.

9.4.3.2.3 Fire on open ro-ro space

Open ro-ro spaces only exist on the *Standard RoPax* and the estimations for this type of ro-ro space are therefore described in section 9.4.3.3.1.

9.4.3.3 Standard RoPax

The *Standard RoPax* is unique in the sense that one of the ro-ro spaces is an open ro-ro space. Open ro-ro spaces are notoriously vulnerable during fire due to the very nature of such spaces, i.e. the total opening area is relatively large and as a consequence the amount of oxygen available for a fire is practically unlimited. In addition to this, fires in open ro-ro spaces are particularly difficult to contain, causing uncontrolled flame and smoke spread, such as on the *Norman Atlantic*, *Lisco Gloria*, and *Sorrento*.

9.4.3.3.1 Evacuation failure due to fire in open ro-ro space

The approach used and the assumptions made to calculate evacuation failure for open ro-ro space involved the following steps, further elaborated below:

1. The size of the fire was defined;
2. The ro-ro space was divided into zones based on the position of LSAs and the safety distance detailed in 9.4.2; and
3. The zones were labeled “critical” or “partially critical”, depending on whether fire occurring within the zone would always lead to evacuation failure (critical) or whether consequences of fire within the zone is dependent on wind direction.

Size of fire

Fires in ro-ro spaces can vary in size, making it challenging to define a size that is representative for all possible scenarios. An attempt to define a characteristic fire with regard to size was made based on the definition of late decision of extinguishing system activation and that the fire cannot be extinguished (only suppressed), which was considered highly related to a decision for evacuation in case the fire is in addition uncontained. This occurs when:

- a) the drencher system is malfunctioning due to technical failure and manual firefighting is insufficient, causing the fire to spread uncontrollably; or
- b) the size of the fire exceeds two drencher sections, exceeding the suppression capabilities of the drencher system.

The latter was used as a basis for the definition of the fire size, i.e. the fire was assumed to correspond to two drencher sections. The size of the fire was in this context thereby given a characteristic length referring to its longitudinal length, assuming that it covers the full width of the ro-ro space.

There are several drencher sections along the length of the open ro-ro space of the *Standard RoPax* ship, and they are not uniform in length. The length of most of the drencher sections on this ship is 20.8 m, which was generalized to 20 meters⁷ in this study. This is a common size of drencher sections on ro-ro ships. The fire size was subsequently estimated to be 20 m multiplied by 2 (two drencher sections), corresponding to a fire size of 40 m.

Fire ignition was assumed to have a uniform probability distribution throughout the ro-ro space and fire was generally assumed to spread symmetrically, i.e. 20 m in each direction. Ignition at 30 m from an end would for example result in a fire in the area 10-50 m from the same end. In case of fire ignition closer than 20 m from an end, it was still assumed to spread to become a 40 m fire (asymmetrically), i.e. in the area 0-40 m from the end. No alterations were made to account for potential end effects, e.g. to account for spread to or from other ro-ro spaces or that fire at an end may not as easily spread in one direction to become 40 m.

Zoning

The total length of the open ro-ro space on the *Standard RoPax* ship, L_{ro-ro} , is 143 m. The ro-ro space was divided in two types of zones, “critical” and “partially critical”, as illustrated by Figure 33.

⁷ It should be noted that this value is consistent with the value taken in the first part of FIRESAFE II

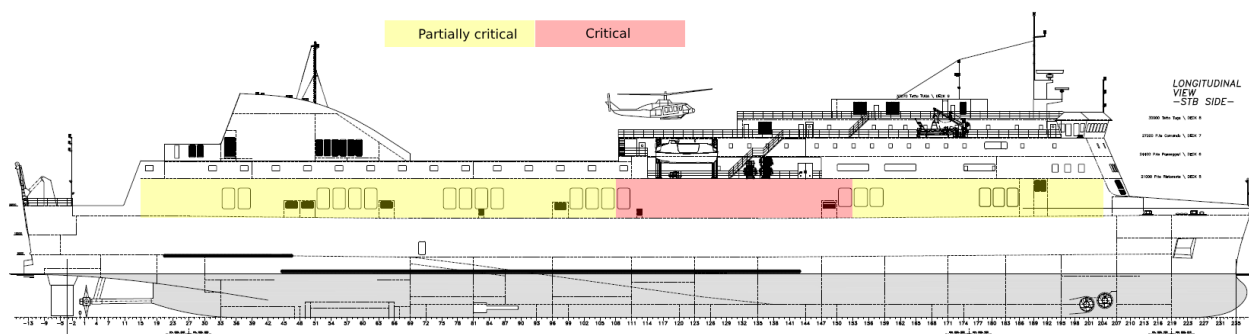

Figure 33: Zoning of open ro-ro space, where the colouring illustrates the different zones (red zone=critical, yellow=partially critical)

The critical zone corresponds to the zone in which fire will result in evacuation failure. Areas in partially critical zones correspond to areas where fire will lead to evacuation failure depending on prevailing wind conditions.

The methodology used to define the critical zone was the following:

- a) There are 20 openings in six clusters on each side for the open ro-ro space and the LSAs are located between the second and third cluster, counted from the bow. One opening in each cluster closest to the LSA are critical openings, i.e. two openings on each side of the ships, since they are within the safety distance (6 m) from LSAs (see paragraph 9.4.2.1).
- b) Fire behind these critical openings was expected to always impede evacuation.

Assuming that the uncontained ro-ro space fire is 40 m in size and that the probability of fire is uniform throughout the ro-ro space (see above), the probability for fire in the critical zone and the partially critical zones were calculated to 54% and 46%, respectively.

If the fire is within a critical zone, it was assumed that evacuation failure will always occur due to flame spread through openings⁸. If a fire on the other hand occurs in a partially critical zone, the probability for evacuation failure was assumed to be contingent on the wind direction. If the wind direction is towards LSAs, evacuation failure will occur. Hence, the probability of evacuation failure due to a ro-ro space fire was estimated to 65%.

Successful suppression was not considered to affect the probability of evacuation failure for open ro-ro spaces, based on that:

- Fire in the critical zone will lead to flame spread to LSAs, and tactical activation of the drencher system in other areas will not impact whether LSAs are affected in the critical zone.
- Fire in partially critical zones will lead to evacuation failure in case of a wind direction towards LSAs, and tactical activation of the drencher system in the critical zone will not affect whether smoke impacts evacuation.

If the drencher system in a ro-ro space is operational but unable to extinguish a fire, the master may redirect the drencher system to zones relevant for protecting LSAs, avoiding fire spread through the openings. Tactical activation of the drencher system in the critical zone may hence reduce the probability of fire spread to the critical zone, which would hence decrease the probability of fire in the critical zone. However, this was not considered in the current fire risk model.

9.4.3.3.2 Fire on weather deck

The *Standard RoPax* ship has two weather decks, as illustrated by Figure 34. Due to the large distance between the weather deck on Deck 4 and the LSAs, as well as the obstructions along the path for the smoke

⁸ It should be noted here and with reference to Figure 33 that no consideration was given to conduction of heat through the structure, since the structural fire integrity under evacuation routes and embarkation stations should be sufficiently thermally insulated in line with SOLAS II-2/9.

to travel through, thus introducing turbulence and intensifying dispersion, it is reasonable to assume that a fire that on this deck will not cause evacuation failure. The weather deck on Deck 5 is closer to the LSAs and within the safety distance from weather deck of 8 m (for stowage). The LSAs are 6 m from the weather deck, which however only includes cars and will not cause as large of a fire as assumed in 9.4.1.1.2.1. Furthermore, the LSAs and the embarkation station are to a large degree screened from a car fire and the 6 m distance was therefore considered sufficient to avoid flame spread, similar to the safety distance from side openings. Flame spread was hence not assumed to be relevant, but smoke spread was assumed to cause evacuation failure if the wind direction is towards the LSA.

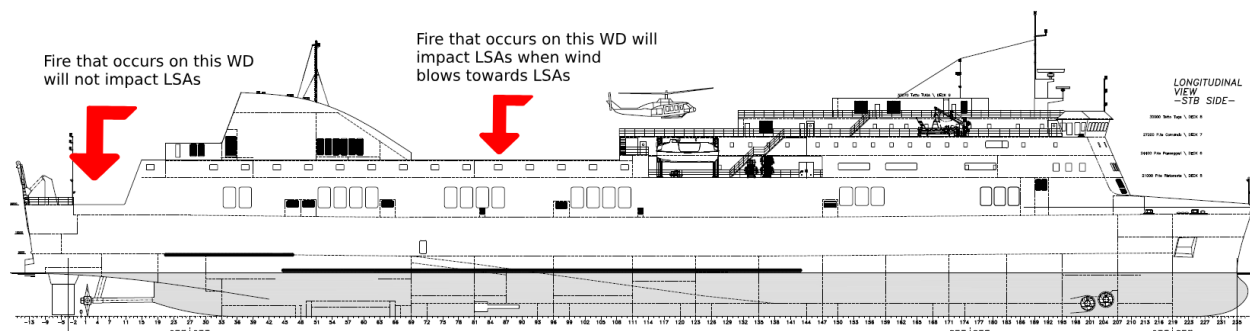

Figure 34: The Standard RoPax has two weather decks, one located in the far aft, and one located in the middle of the ship. Only fire on the latter one was deemed to cause evacuation failure given that the wind blows towards LSAs

The probability of evacuation failure due to fire on weather deck was calculated based on the probability of fire occurring on the weather deck on deck 5 (67%) and on the probability of wind in the direction of the LSAs (25%), resulting in a 17% failure rate.

9.4.3.4 Ferry RoPax

The LSAs on the *Ferry RoPax* are located right above the aft opening, making them susceptible to fire from the weather deck and parts of the closed ro-ro space of Deck 5.

9.4.3.4.1 Evacuation failure due to fire in closed ro-ro space

Fire close to the aft opening on the *Ferry RoPax* was assumed to cause evacuation failure since the LSAs are located almost right above the opening. To calculate the probability of a closed ro-ro space fire impeding LSAs, the proportion of fires occurring in the space was first calculated. Then, the same methodology was used as for the open ro-ro space described in 9.4.3.3.1 for calculating the probability of a fire occurring at the aft opening. It was assumed that if a 40 m fire is within the first 20 m of the space (within the first drencher section), it will have an impact on the LSA. This was the basis for calculating the probability for flames impacting evacuation.

With regard to smoke spread, it was assumed that an uncontained and unsuppressed fire in the closed ro-ro space will always cause smoke exiting through the aft opening in front of the weather deck. However, in case the fire is uncontained but suppressed, it was assumed to give smoke spread through the end opening only in case the fire is within 20 m from the opening. Hence, a fire within 20 m from the end will result in flame spread through the opening, which was included above, and a fire further away from the opening will result in smoke spread in case the fire is unsuppressed. If the fire further than 20 m away from the aft opening is suppressed, it was not considered to cause evacuation failure, based on the assumption that the two aft drencher sections will cool and wash down the smoke sufficiently to avoid significant impact on evacuation. The wind direction was not considered to have any impact on evacuation failure for the *Ferry RoPax*, due to the proximity of the LSA to the aft opening.

The probability of unsuccessful evacuation due to fire in the *Ferry RoPax* closed ro-ro space in front of the weather deck was estimated based on the space proportion of all closed ro-ro spaces (39%), the probability of fire 20 m from the aft opening (29%) and the probability of fire in the rest of the space (71%) to a total of 11% in case of suppression and to 39% in case of unsuccessful suppression.

9.4.3.4.2 Evacuation failure due to fire on weather deck

Evacuation failure generally depends on the location and extent of a fire on weather deck and on the wind direction. However, the weather deck in this case is very small and the LSAs are directly above and in front of the weather deck, i.e. within the safety distance from LSAs. Evacuation failure was therefore always assumed to occur in case of an uncontained weather deck fire on a *Ferry RoPax* ship, due to the radiation from the flames directly impacting LSAs. An uncontained fire on the *Ferry RoPax* weather deck was hence assumed to result in evacuation failure in 100% of the uncontained weather deck fires.

9.4.3.5 Cargo RoPax

The LSAs on the *Cargo RoPax* ship are not within the safety distance from the weather deck, and radiation from flames on the weather deck will thus not impede evacuation. However, smoke from the weather deck or closed ro-ro space fire may cause evacuation failure, depending on the wind direction.

9.4.3.5.1 Evacuation failure due to fire in closed ro-ro space

The closed ro-ro space in front of the weather deck on the *Cargo RoPax* is quite small (representing 21% of the closed ro-ro spaces) and an uncontained fire will therefore always be close to the aft opening. Thanks to the large distance from the opening to the LSAs (21 m), they will not be impeded by flames from the fire but the smoke may cause evacuation failure depending on the wind direction. The probability of evacuation failure due to fire in the closed ro-ro space on the *Cargo RoPax* was hence calculated based on the proportion of fires occurring in the closed ro-ro space in front of the weather deck (21%) and on the probability of wind towards the LSAs (25%) to a total of 5.1%.

9.4.3.5.2 Evacuation failure due to fire on weather deck

Flames from a fire close to the aft opening on the *Cargo RoPax* were assumed to not affect evacuation, since the LSAs are located at a safe distance from the weather deck.

With regard to smoke spread, it can be assumed that an uncontained weather deck fire will always produce a large amount of smoke. Smoke from an uncontained fire on weather deck was assumed to always impact the LSAs in case of wind in the direction of the LSAs, which was assumed to occur in 25% of the cases. This is a quite conservative assumption, that even a fire 50 m away from the LSAs will cause evacuation failure in case of wind towards the LSAs. However, evaluation of the impact of smoke on LSAs (primarily humans embarking) has not been included in this study, where focus has been on the impact of heat on LSAs. This assumption was soundly applied for the smaller weather decks on *Ferry* and *Standard RoPax* ships and the same assumption was applied to the large weather deck on the *Cargo RoPax*, even if it is a very conservative assumption. This was done to avoid defining an arbitrary value for a safe distance for the LSAs with regard to smoke spread. To define such a value, a more detailed study on the effects of smoke spread on LSAs depending on vertical and horizontal distances, wind, etc. would be needed, including tests and simulations. Regardless of the position of the fire on the weather deck, the smoke was hence assumed to possibly reach the LSAs in case of wind in their direction. This assumption is supported by the lack of obstructions between the weather deck and the LSAs.

9.4.3.6 Limitations

One important assumption is size of the fire. For closed and open ro-ro spaces, the size of the fire was assumed to be 40 m in case of containment failure, which must occur for evacuation to be impacted in the model. Furthermore, size of fire was defined within the context of unsuppressed fire, but it was also applied for suppressed fire. While it is reasonable to assume that an unsuppressed fire will be larger, applying it for suppressed fires is a conservative approach. On the other hand, in the case of unsuppressed fire it was reasoned that a fire is by definition unsuppressed when it exceeds two drencher zones, and the latter typically corresponds to 40 m or more in longitudinal length. This means that 40 m is the lowest possible value that could be applied, since a fire larger than 40 m would also exceed two drencher zones. 40 m is therefore a less conservative value compared to the possible values that could be used based on the assumptions for size of fire.

9.5 Risk quantification

Based on the risk model described above, the Potential Loss of Life were compiled for the three vessels categories (Newbuildings and Existing ships), as presented in Figure 35.

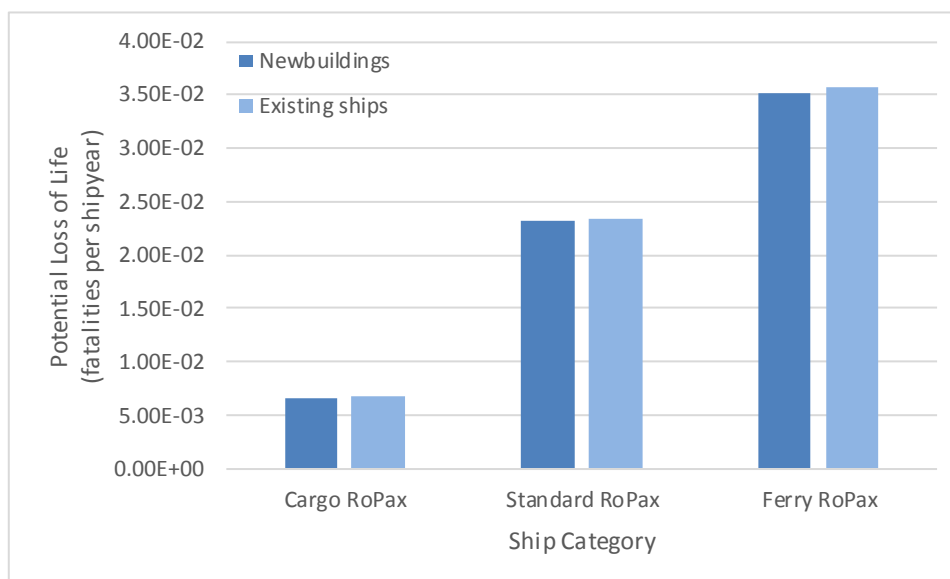

Figure 35: Potential Loss of Life (PLL) for the three generic ships considered

In comparison with the PLL derived from historical data reported in the first part of FIRESAFE II (EMSA, 2018), the PLL figures derived from the event risk model are lower. Although the consequence part of the main fire risk model was developed to be representative of the average consequences of accidents, it should be noted that a single accident leading to a high number of fatalities within a limited period in time may skew the estimated historical societal risk. This may create a difference between the estimated historical societal risk and the risk estimated with the risk model. Furthermore, the number of passengers onboard the *Al Salam Boccaccio 98* at the moment of the accident exceeds the passenger capacity of the *Ferry RoPax* considered in this study.

It should be noted that the PLL of the *Cargo RoPax* is much lower than the PLL of the *Standard RoPax* and *Ferry RoPax* mainly due to the low passenger capacity of the *Cargo RoPax*. A low difference between the PLLs for Newbuildings and Existing ships was found, mainly due to the fact that the only difference considered in this study is the non-addressability of the detection systems on *Existing ships*.

In addition to the risk to human life, the risks to the property (cargo and ship) were considered. The Potential Loss of Cargo and Potential Loss of Ship were estimated and are presented in Figure 36. Similar to the first FIRESAFE study, no differences in the ship damage between Existing ships and Newbuildings were considered.

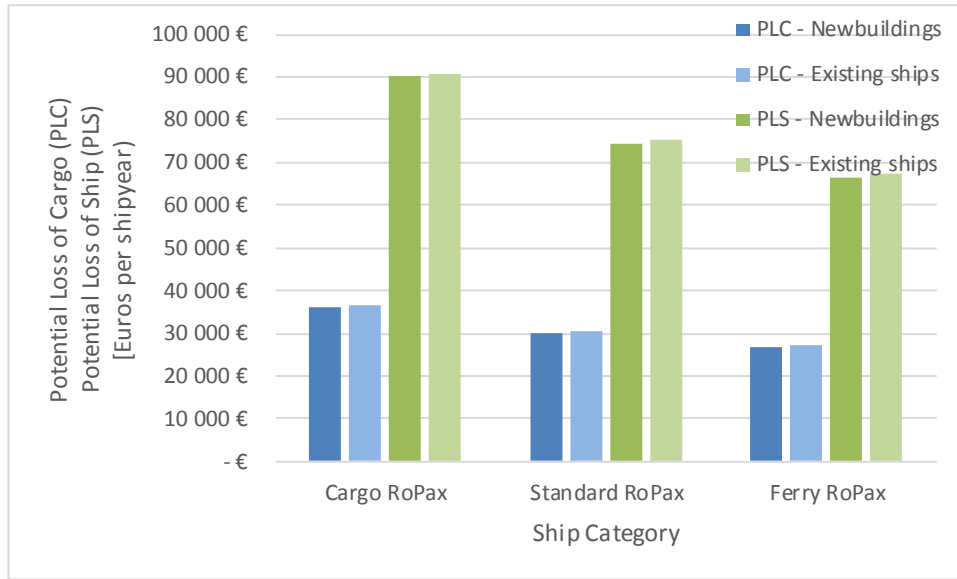

Figure 36: Potential Loss of Cargo (PLC) and Potential Loss of Ship (PLS) for the three generic ships considered

10 RISK CONTROL OPTIONS - CONTAINMENT

To propose effective and practical risk control options (RCOs) for further evaluation, the following stages were considered:

- Focus on risk areas requiring control;
- Identification of potential risk control measures (RCMs);
- Evaluation of the effectiveness of the RCMs; and
- Grouping of RCMs and selection of suitable RCOs for further cost-effectiveness analysis (CEA).

Containment of fire in ro-ro spaces is very important for the safety of passengers. Fire containment may fail in many ways, identified in a hazard identification workshop (see 8.1 Hazard Identification – Containment) where risk control measures were also identified. Structured analysis in several workshops comprising experts from fire research, classification society and industry led to the selection of a limited number of RCOs, evaluated more deeply.

10.1 Identification of RCOs

A list of risk control measures (RCMs), related to the hazards identified in previous steps, were registered together with RCMs already identified in previous projects. The complete list of identified RCMs is presented in Annex A1.7, where they are categorized as Best practice, Boundary cooling, Cables, Closure, Completeness of boundaries, Explosion, Fire insulation, Smoke management, Smoke tightness and Sub-division.

Table 32: Top-ranked RCMs to avoid containment failure

RCM category	RCMs	Denomination
Boundary cooling	Fire monitors on weather deck	Fire monitors on weather decks
Closure	Permanent closure of openings for ro-ro spaces (for both closed and open ro-ro spaces)	Ban/closure of side & end openings
Completeness of boundaries	Further developed procedures for installation, inspection and maintenance of penetrations by documentation of how planned work affects the fire integrity of boundaries (before work is initiated) and control of installations afterwards.	Procedures for penetrations
Fire insulation	Requirement for A-30 (at least) fire insulation instead of A-0 between ro-ro spaces.	Fire insulation A-30 between ro-ro spaces
Fire insulation	Increased fire insulation for ro-ro space boundaries (e.g. A-180 towards accommodation areas)	Increase of fire insulation
Smoke management	Operation of the ship in a beneficial direction, e.g. up against the wind, to avoid smoke spread to the bridge, embarkation stations, etc.	Ship operation
Smoke tightness	Implementation of new fire test and requirement (already in place by A-class definition) for enhanced smoke-tight A-60 divisions for ro-ro space boundaries (i.e. for main fire zones).	New standard test for ro-ro space doors

The RCMs were initially ranked by experts for their risk reduction potential and expected costs. The ratings in Annexes A1.8 and A1.9 summarize the results from this ranking process. The RCMs with the highest potential based on this ranking are summarized in Table 32.

10.2 Detailed description of relevant RCOs

This section contains a detailed description of the top-ranked risk control options identified in the pre-screening process of risk control measures to avoid ro-ro space fire containment failure.

10.2.1 *Fire monitors on weather decks*

For ro-ro passenger ships with a weather deck, fixed fire protection arrangements (here fire monitors) shall be provided for the purpose of containing a fire in the space or area of origin (i.e. the weather deck) and to cool adjacent areas to prevent fire spread and structural damage.

In its best practices document (see MSC 96/6/2), Interferry suggested manual or automatic water monitors should be considered by operators for all ships with weather decks.

10.2.1.1 *Benefits*

Weather deck is fairly unprotected in case of fire, and cooling possibilities are limited with no means for local cooling. In a case of a fire on weather deck, the use of fire monitors might contain the propagation of the fire by reducing the amount of radiation from flames, and depending on the discharging rate, suppression or even extinguishment of the fire might be reached.

10.2.1.2 *Critical aspects*

Some critical aspects of the installation of a fire monitor on a weather deck might be discussed. The fire monitor requires the installation of a new system of extinguishment.

Depending of the water discharge, the stability of the ship might be impacted if the water evacuation on the weather deck is too little comparing to the amount of water.

Furthermore, during a fire, if a fire monitor is activated, the water vapour might directly go to accommodations if the wind direction has been not taken in account with regard to the ship navigation direction.

10.2.2 *Ban/closure of side & end openings (closed and open ro-ro spaces)*

Both open and closed ro-ro spaces have openings that could be closed. Ro-ro spaces are defined as closed also if there is an opening at one end and side openings are less than 10% of the total area of the space sides. (SOLAS II-2/3.12)

This risk control measure implies to forbid open ro-ro spaces on new ships and to reduce openings in general as far as practicable. The benefits are discussed below but it should also be considered that the open ro-ro space concept was developed to adapt to risks associated to different types of cargo, requiring a lot of ventilation. Without ro-ro space openings, a larger deck area would be needed for cargo requiring large ventilation, such as dangerous goods and livestock.

10.2.2.1 *Benefits*

From a containment point of view, the main benefit of fewer openings is to avoid smoke and flames escaping from the fire enclosure, preventing propagation of the fire to spaces above the opening and harmful exposure to smoke.

10.2.2.2 *Critical aspects*

Closure of openings on Existing ships would imply that increased mechanical ventilation capacity is needed, requiring a rather extensive and costly installation. It would also lead to increased fuel consumption since additional power supply is needed. If additional power is not available, it will imply installation of additional auxiliary engines for power supply. This is costly, technically challenging and will likely affect cargo capacity.

As mentioned above regarding the intention of introducing the open ro-ro space concept, a critical aspect would be potential loss of cargo, due to restrictions regarding e.g. carriage of dangerous goods or live stock in closed ro-ro space. Commercially this could also affect the customer to choose a different route/ship/company for all of its cargo, meaning that the ship owner will not only lose the dangerous cargo but potentially also important customers and market shares.

10.2.3 *Procedures for penetrations*

As shown in the fault tree for containment, one issue with containment failure (in terms of flame and smoke propagation) is the unsealed penetrations after a maintenance or renovation work.

The current RCO is the development of procedures for installation, inspection and maintenance of penetrations by documentation of how planned work affects the fire integrity of boundaries (before work is initiated) and control of the installations afterwards.

The procedure might be a meeting between workers before a maintenance work is initiated, where potential penetrations are planned and documented. This meeting will lead to the development of a guideline dedicated to this specific work and the work will be closed by a meeting between workers, with a special control of the sealing of the penetrations.

10.2.3.1 *Benefits*

The major benefit here is that procedures avoiding unsealed penetration may dramatically reduce the risk of unexpected fire propagation.

10.2.3.2 *Critical aspects*

The critical aspect of this RCO is the increased time required for the work compared to the same work without this procedure in place.

10.2.4 *Fire insulation A-30 between ro-ro spaces*

Currently, the SOLAS Convention does not require any fire insulation horizontally between ro-ro spaces of the same type.

There have been many examples of ro-ro ship fires where the fire has spread to the deck above due to heat transfer through the ro-ro deck structure.

10.2.4.1 *Benefits*

The requirement for at least A-30 fire insulation instead of A-0 between ro-ro spaces will avoid or at least delay fire spread between ro-ro spaces.

10.2.4.2 *Critical aspects*

The application of this RCO may only be feasible for new ships. For Existing ships, the cost for installation will be high, but more importantly, the addition of fire insulation may imply stability problems.

10.2.5 *Increase of fire insulation*

Thermal or fire insulation is installed in order to avoid or delay propagation of fire through structures due to heat conduction. An increase of fire resistance properties of a fire insulation will allow a larger delay of (or avoid) fire propagation. The fire rating of A-class divisions, A-XXX, is determined by a standard fire test in accordance with Part 3 of the FTP Code, where the time XXX is given by the time during which the unexposed surface of the division will not exceed a certain temperature increase.

10.2.5.1 *Benefits*

The increased capacity of the fire insulation will reduce or avoid the fire propagation potential from ro-ro spaces to other spaces.

10.2.5.2 Critical aspects

The application of this RCO may only be feasible for new ships. For Existing ships, the cost of installation may be too high, but more importantly, the addition of fire insulation may imply stability problems.

It should also be added that new studies (Koneck & Galaj, 2017) have shown that the increase of fire insulation for a closed space will induce increased room temperatures and could affect the severity of the fire.

10.2.6 Ship operation

When a fire occurs on a weather deck, a procedure will be developed for how to operate the ship in a beneficial direction (up against the wind for instance).

This RCO was mainly proposed to manage fires on weather deck, even if it can also be applied for a fire in closed or open ro-ro spaces, for smoke management and not as a containment RCO.

10.2.6.1 Benefits

By operating the ship in a beneficial direction, smoke is transported away from the ship and smoke and fire spread to the bridge or to accommodation spaces is avoid.

10.2.6.2 Critical aspects

Operating the ship during a fire incident may be difficult. It may cause other types of accidents, such as collision and grounding.

10.2.7 New standard test for ro-ro space doors

The IMO has developed fire safety regulations in SOLAS and related verification procedures for structures and materials in the FTP Code. They are to a large degree based on fire tests developed by the International Organization of Standardization (ISO), covering many different tests for constructions.

The A class divisions surrounding ro-ro spaces shall per definition be capable of preventing the passage of smoke and flame. Part 3 of the FTP Code includes the fire resistance test procedures for A class divisions and this test procedure is very similar to the ISO test procedure in ISO 834-1. However, the FTP Code specifies, regarding measurements on the test specimen:

(Annex 1: Part 3, 8.4.3.1): Tests with the cotton-wool pad are used to indicate whether cracks and openings in the test specimen are such that they could lead to the passage of hot gases sufficient to cause ignition of combustible materials.

(Annex 1: Part 3, 8.4.6): If quantities of smoke are emitted from the unexposed face this shall be noted in the report. However, the test is not designed to indicate the possible extent of hazard due to these factors.

Hence, the test described for A-class divisions or doors of this class is not designed to evaluate hazards associated with smoke spread but only related to fire spread (including spread of smoke causing fire spread). The fire test is very similar to that for land-based building products in ISO 834-1, and also here this is a well-known problem – that A-class divisions or doors can spread a lot of smoke, even if it does not ignite the cotton pad in the fire test. For buildings, there is for this reason a specific requirement for smoke tightness, in particular for certain doors, marked by the addition “-s”. The problem with the conventional test (in accordance with Part 3) is that there is a neutral plane in the furnace, against which the test specimen (e.g. a door) is fitted. In the upper part of the door there will hence be an over pressure and under the door an under pressure. Thereby, a gap under the door⁹ will seldom cause fire spread in a test, since primarily

⁹ SOLAS II-2/9.4.1.1.2: “The construction of doors and door frames in “A” class divisions, with the means of securing them when closed, shall provide resistance to fire as well as to the passage of smoke and flame equivalent to that of the bulkhead in which the doors are situated, this being determined in accordance with the Fire Test Procedures Code. Such doors and door frames shall be constructed of steel or other equivalent

ambient air is here sucked into the furnace. In a real fire scenario it is although common with an over pressure over the whole door and smoke can spread through this gap. This is a big problem – both that A-class per definition requires smoke tightness but that this is not tested, and that some A-class doors may spread a lot of smoke in a real fire scenario. This may be particularly problematic on a ro-ro ship and may cause smoke spread to the accommodation part of the ship. This RCO implies that a criterion for the smoke tightness of A class divisions is implemented into the FTP Code, Part 3 fire test procedures, which would in particular apply to all A class doors (not to solid steel decks or bulkheads).

10.2.7.1 Benefits

The implementation of a criteria for smoke tightness in the FTP Code Part 3 will ensure smoke containment for A-class divisions in case of fire.

10.2.7.2 Critical aspects

The most critical aspect of this RCO is the cost associated with the necessity to perform this standard test for all already installed divisions on Existing ships. Even for newbuildings, the division suppliers will need to re-certify their existing solutions against the new standard test including the smoke tightness criterion.

10.3 Selected RCOs

Two of the RCOs listed in the Table 32 were ultimately selected for further cost-effectiveness analysis, based on their initially judged potential as well as on their feasibility, technology readiness level, availability and expected costs. Those RCOs are:

- **Cont1** Ban/closure of side & end openings for ro-ro spaces (for both closed and open ro-ro spaces).
- **Cont2** Fire monitors on weather deck.

10.4 Technical specifications of RCOs

10.4.1 *Ban/closure of side & end openings*

This risk control measure implies to forbid open ro-ro spaces on new ships and to reduce openings in general as far as practicable. Ro-ro spaces are defined as open if it has two open ends or one end with at least 10% openings provided in the sides of the ship (SOLAS II-2/3.12). Hence, closed ro-ro spaces can have quite significant openings and both open and closed ro-ro spaces have openings which could need to be closed based on this RCO. It includes closing all ro-ro space openings as far as it is practicable. This means that some openings may be left, for critical functions, but on the generic ships no such openings were found for the closed ro-ro spaces.

Openings in the sides of the ship were in this RCO assumed to be welded shut on Existing ships and omitted on newbuildings, making the spaces permanently enclosed. The fire integrity of the covered openings should achieve the same requirements as the rest of the division, which towards external areas or open deck generally is A-0, in accordance with SOLAS II-2/9. This implies a non-combustible structure which is constructed to prevent the passage of smoke and flame for 60 minutes, but which may conduct heat momentarily.

Except from closing the ship side openings as far as practicable, the end openings need to be closed. This may be achieved in any way, for example by a roller shutter, gate or ramp, as long as it is certified for marine use (Wheel Mark) and achieves suitable fire integrity requirements. The purpose of the closing device is to avoid fire spread and achieve containment for the ro-ro space to which it is installed. Based on the maritime regulatory framework, the most relevant requirement for end closing devices appears to be A-0, but this

material. Doors approved without the sill being part of the frame, which are installed on or after 1 July 2010, shall be installed such that the gap under the door does not exceed 12 mm. A non-combustible sill shall be installed under the door such that floor coverings do not extend beneath the closed door.”

could be a bit conservative and difficult to achieve for a suitable device. The most important functions are avoidance of flame spread and minimization of smoke spread. It is relevant to require the division to be constructed of non-combustible material.

In addition to the above specifications, means will need to be provided to fulfil regulations with regard to ventilation of the ro-ro space, in particular if closing an existing open ro-ro space. Such ventilation system would need to achieve relevant regulations in SOLAS II-2/20 and could imply significant additional costs and installations to account for the increased requirement for ventilation. Furthermore, it must be made sure that the closed openings (primarily end opening devices) do not block other important functions, such as fire patrols, drainage, detection system, drencher system, etc.

10.4.2 *Fire monitors on weather deck*

Fire monitor systems are chosen so that existing drencher pumps and sea chests can be used for water supply.

This means the drencher and the fire monitor systems will affect each other if they are operated simultaneously and full effect on both systems will not be possible. The design idea is that the water monitors represent a fixed extinguishing system for weather deck, hence using drencher pumps is logical for this installation.

Deck area, pump capacity and obstructions on deck will govern the type of monitor end the number of monitors to be used. The chosen monitor type can reach approximately 35-50 meters depending on weather condition and operates approximately 1000 litres per minute at 5-8 bar.

The chosen system has possibility for remote control. It shall be noted that a system without remote control feature would require a safe positioning of the monitor and proper personal protective equipment (PPE) for the person operating the monitor (most likely full fire-fighting equipment including BA-set would be required).

10.5 Quantification of RCO effectiveness

10.5.1 *Ban/closure of side & end openings for ro-ro spaces (for both closed and open ro-ro spaces)*

The permanent closure of openings in the ship sides (including ends) were considered to affect two nodes of the containment fault trees for closed and open ro-ro spaces, namely:

- Failure of fire containment due to flame spread through openings in the ship sides; and
- Failure of smoke containment due to external smoke spread failure by spread through the openings.

The RCO was also considered to affect two nodes of the weather deck containment fault tree:

- Failure of fire containment due to flame spread; and
- Failure of smoke containment due to smoke spread.

For closed ro-ro spaces, the main impact of permanent closure of openings was considered to be related to closure of the end opening/s. Furthermore, potential openings in the sides of the ship could extend to up to 10% of the area of the ship sides, which is a quite extensive area. However, closed ro-ro spaces close to the water line (main deck) and below the main deck do not have any openings (except potential gaps in ramps) and openings in the sides of the ship for closed ro-ro spaces further up in the ship are seldom this large (seldom close to 10% of ship sides).

For the existing side openings in closed ro-ro spaces it should be considered that most of them are there for a reason and that openings will only be reduced as far as “practicable” by this RCO. Hence, many of the current side openings were considered to still be left after implementation of this RCO, such as some openings around mooring stations, for drainage, for ventilation inlets and outlets (which could spread fire and smoke in case fire dampers do not exist or are not closed), etc. The main impact by this RCO was therefore considered to come from closing the end openings for decks above the main deck.

Furthermore, it was considered that for example an 80% closure of the total area of openings will not result in a reduced failure of fire or smoke containment due to spread through the openings by 80%. In other words,

the relative reduction of the opening areas is not directly related to a reduction in containment failure probability. If one imagines a ship with openings every other meter and then decides to remove 4 out of 5 openings, there is still an opening every 10 meters, which can still spread fire. Fire will not be spread as easily as with openings every other meter but the risk will not be reduced by 80% (4/5). The impossibility to close all the openings completely (some openings will still exist for ro-ro spaces above the water line) will give a relatively lower impact on the corresponding reduced probability of failure than the reduction in opening areas. In particular openings left distributed over the whole ro-ro space (in particular openings in the ship sides - not ends) will reduce the impact of this RCM.

The proportion of closed ro-ro spaces which are already completely closed (close to or below water line) for the selected generic ships was considered in the initial estimation of the failure probability. For the closed ro-ro spaces with existing openings, closure of the end opening/s and unnecessary side openings was approximated to represent a closure of 80% of the existing openings, based on rough estimates of the sizes of the openings. This figure is mainly represented by closure of the end openings as well as by closure of a relatively small proportion of the side openings. The existence of some openings in the ship sides will although, as state above, results in a reduced impact of closing the openings in general. The total impact of closing 80% of the area of openings in closed ro-ro spaces was estimated by expert judgement to give:

- 50% reduction in failure of fire containment due to flame spread through openings in the ship sides from closed ro-ro spaces; and
- 50% reduction in failure of smoke containment due to external smoke spread failure by spread through the openings from closed ro-ro spaces.

This figure was initially estimated for *Standard RoPax* ships, and the resulting failure rates were then applied to the closed ro-ro spaces on the *Ferry RoPax* ship and *Cargo RoPax* ship after implementation of this RCO (after closure of aft openings). The resulting failure rates were considered to apply for all RoPax ship types. The reductions in failure probabilities to reach the same new failure rates as for *Standard RoPax* closed ro-ro spaces (without any significant openings) are presented in Table 34 and Table 35 for *Cargo RoPax* and *Ferry RoPax* ships, respectively. Furthermore, the failure probabilities were adapted to the *Standard RoPax* figures for successful and unsuccessful suppression.

Open ro-ro spaces would be closed to the same extent as the above considered closed ro-ro spaces, i.e. both the permanent openings provided for ventilation, and the other end and side openings discussed previously. Hence, the final result will be that open ro-ro spaces and closed ro-ro spaces (above the water line) will have the same design of openings and should result in the same failure rate. Since the initial failure rate for loss of fire containment due to flame and smoke spread were about 10 times higher for open than for closed ro-ro spaces, respectively, the failure probability reduction was estimated to give:

- 95% reduction in failure of fire containment due to flame spread through openings in the ship sides from open ro-ro spaces; and
- 95% reduction in failure of smoke containment due to external smoke spread failure by spread through the openings from open ro-ro spaces.

The initial ambition was that this would result in approximately the same failure rates as for the closed ro-ro spaces with further permanently closed openings (primarily end openings). However, closure of the openings of open ro-ro spaces also imply certain negative side effects which have been considered for closed ro-ro spaces and which now also need to be considered for closed formerly open ro-ro spaces. The closed ro-ro spaces primarily have an increased probability of containment failure from internal smoke spread, due to potential pressure build-up and less natural ventilation, which is not captured by simply reducing the probability of having side openings. Therefore, instead of using the above failure probability reductions only related to the openings, reference was made to the total containment failure probability for closed ro-ro spaces with reduced openings in the fire risk model.

Another issue that was considered in these estimations was that open ro-ro spaces made into closed ro-ro spaces on Existing ships could have more damaged fire insulation, doors or other equipment, due to long-term exposure to the harsh environment in open ro-ro spaces. However, this potential difference between Existing ships and Newbuildings in the containment failure probability was considered marginal and uncertain and it was therefore not considered in the risk model.

For weather deck, this RCO also has an impact on two nodes similar to those for closed and open ro-ro spaces. Closure of closed and open ro-ro space ends will imply that the probability for fire spread from weather deck to these spaces will be reduced. Since fire may still spread in other ways and to other areas of the ship, the impact on the failure probability reduction was estimated to give:

- 35% reduction in failure of flame containment due to smoke spread.; and
- 35% reduction in failure of smoke containment due to smoke spread.

The affected nodes, the risk reduction potential for this containment RCO and affecting factors are summarized in Table 33, Table 34 and Table 35 for *Standard RoPax*, *Cargo RoPax* and for *Ferry RoPax*, respectively.

Table 33: Reduction of failure probability for containment nodes impacted by considered RCO for *Standard RoPax*

RCO	Affected nodes	Affecting factors	Closed Open WD		
Ban/closure of side & end openings	Failure of fire containment - Flame spread through openings - Openings	Reduced area of openings, closure of ends but some necessary sides still open, reduction of risk of open ro-ro spaces to the level of closed.	50%	95%*	-
	Failure of smoke containment - External smoke spread - Spread through openings	Reduced area of openings, closure of ends but some necessary sides still open, reduction of risk of open ro-ro spaces to the level of closed.	50%	95%*	-
	Failure of fire containment - Flame spread	Closure of ends by shutter, hindering flame spread to adjacent space.	-	-	35%
	Failure of smoke containment - Smoke spread	Closure of ends by shutter, hindering smoke spread to adjacent space.	-	-	35%

* Instead of applying this failure probability reduction, reference was made to the resulting figure for closed ro-ro spaces in the fire risk model, to consider side-effects of significant closure of openings.

Table 34: Reduction of failure probability for containment nodes impacted by considered RCO for *Cargo RoPax*

RCO	Affected nodes	Affecting factors	Closed		WD
			Suc	Unsuc	
Ban/closure of side & end openings	Failure of fire containment - Flame spread through openings – Openings	Reduced area of openings, closure of ends but some necessary sides still open, reduction of risk of open ro-ro spaces to the level of closed.	98%	88%	-
	Failure of smoke containment - External smoke spread - Spread through openings	Reduced area of openings, closure of ends but some necessary sides still open, reduction of risk of open ro-ro spaces to the level of closed.	83%	78%	-
	Failure of fire containment - Flame spread	Closure of ends by shutter, hindering flame spread to adjacent space.	-	-	35%
	Failure of smoke containment - Smoke spread	Closure of ends by shutter, hindering smoke spread to adjacent space.	-	-	35%

Table 35: Reduction of failure probability for containment nodes impacted by considered RCO for *Ferry RoPax*

RCO	Affected nodes	Affecting factors	Closed		WD
			Suc	Unsuc	
Ban/closure of side & end openings	Failure of fire containment - Flame spread through openings - Openings	Reduced area of openings, closure of ends but some necessary sides still open, reduction of risk of open ro-ro spaces to the level of closed.	95%	86%	-
	Failure of smoke containment - External smoke spread - Spread through openings	Reduced area of openings, closure of ends but some necessary sides still open, reduction of risk of open ro-ro spaces to the level of closed.	86%	84%	-
	Failure of fire containment - Flame spread	Closure of ends by shutter, hindering flame spread to adjacent space.	-	-	35%
	Failure of smoke containment - Smoke spread	Closure of ends by shutter, hindering smoke spread to adjacent space.	-	-	35%

10.5.2 *Fire monitors on weather deck*

Fire monitors on weather deck were considered to affect two nodes of the containment fault trees for closed and open ro-ro spaces, namely:

- Failure of fire containment due to flame spread through openings in the ship sides; and
- Failure of smoke containment due to external smoke spread failure by spread through the openings.

The RCO was also considered to affect three nodes of the weather deck containment fault tree:

- Failure of fire containment due to flame spread;
- Failure of fire containment due to heat spread; and
- Failure of smoke containment due to smoke spread.

Water monitors on weather deck were considered as a means for containment, primarily thanks to the possibility to prevent fire spread from adjacent ro-ro spaces (normally in front of the weather deck). It also provides a means for boundary cooling of the weather deck in case of a fire in the ro-ro space below. It was although not considered to reduce any risk for fire spread downwards from the weather deck, since this risk was considered marginal thanks to air between cargo and the deckhead in the ro-ro space below. The RCO will furthermore contribute to containment by the possibility to perform tactical boundary cooling, preventing fire spread to accommodation or adjacent ro-ro space in front of the weather deck.

With regard to boundary cooling on weather deck to prevent fire spread from the space underneath, this was estimated based on the general arrangements of the generic ships, namely by calculating the proportion of the closed and open ro-ro spaces having a weather deck above them. In addition, a reliability of the RCO of 90% was assumed. The resulting reduction in failure of fire containment due to heat spread and failure of boundary cooling for closed and open ro-ro spaces are:

- 30% (33% x 90%) reduction in failure of fire containment due to heat spread and failure of boundary cooling for **closed** ro-ro spaces on *Cargo RoPax* ships.
- 4.5% (5% x 90%) reduction in failure of fire containment due to heat spread and failure of boundary cooling for **closed** ro-ro spaces on *Standard RoPax* ships.
- 45% (50% x 90%) reduction in failure of fire containment due to heat spread and failure of boundary cooling for **open** ro-ro spaces on *Standard RoPax* ships.
- 4.5% (5% x 90%) reduction in failure of fire containment due to heat spread and failure of boundary cooling for **closed** ro-ro spaces on *Ferry RoPax* ships.

With regard to prevention of flame spread from closed ro-ro spaces in front of the weather decks, estimations were made of the probability that a fire would occur in the first row of trucks (24 m) of the closed ro-ro space, based on the general arrangements of the generic ships. This figure was assumed to apply in case of successful suppression of the fire, while the probability of a fire occurring in one of the first two rows of trucks was used in case of unsuccessful suppression. The results are different depending on the type of ship, due to the varying distributions of ro-ro spaces, and they consider a 90% reliability of the fire monitor system. The resulting probabilities are presented for *Cargo RoPax*, and *Ferry RoPax* in Table 36 and Table 38, respectively.

In addition to flame spread through openings to ro-ro spaces in front of weather decks, the RCO was considered to also have an effect on the potential for flame spread through openings for ro-ro spaces underneath the weather deck. Both open and closed ro-ro spaces can have equally significant openings below weather decks in the aft, since this is where mooring stations are often located with significant local openings also for closed ro-ro spaces. However, on the selected generic ships, the closed ro-ro spaces under weather decks have very limited openings, if any. Fire spread from a closed ro-ro space to weather deck was therefore not considered.

From open ro-ro spaces both flame spread through an aft opening and through side openings were although considered possible. This may be possible to prevent by means of fire monitors, but both their reliability and capacity (coverage, spray angle, obstructions, possibility to reach the perimeter of cargo on weather deck, etc.) need to be considered and will affect these possibilities. The reliability and possibility to avoid flame spread to the weather deck by use of fire monitors was assumed to be represented by an assumed 90% reliability of the system. Furthermore, it needs to be considered that not all of the open ro-ro space openings are under a weather deck, but that one third of the space is underneath the accommodation part of the ship. To determine the weight of this failure node (flame spread through opening) attributed to flame spread to weather deck, consideration was further taken to that flame spread through the aft opening is more likely than through side openings and that flame spread to the weather deck is more likely than to the accommodation part of the ship (only through openings in the hull side or exposed combustible materials). An estimation of the reduction of containment failure due to flame spread through the open ro-ro space after implementation of the RCO was based on the following assumptions for flame spread from the open ro-ro space:

- 50% of the cases stem from fire in the aft third of the space, since flame spread through openings will occur in 100% of the scenarios (to the weather deck above of aft of the space).
- 37.5% of the cases stem from fire in the mid third of the space, since flame spread through openings will occur in 75% of these scenarios (to the weather deck above).
- 12.5% of the cases stem from fire in the front third of the space, since flame spread through openings will occur in 25% of these scenarios (to accommodation).

Based on the above assumptions and estimations, flame spread through openings would be possible to avoid by this RCO in 87.5% of the cases. With consideration to a 90% reliability of the RCO, the impact on the failure probability of flame spread through openings was estimated to 78.75%. This proportion of loss of containment due to flame spread through openings was assumed to apply regardless of suppression or unsuccessful suppression (with has been assigned different original failure spread probabilities). The resulting reduction in failure of fire containment due to flame and heat spread through openings in the ship sides from closed and open ro-ro spaces are presented in Table 36.

With regard to boundary cooling on the actual weather deck (effects on extinguishment are considered in the combined assessment in the Combined assessment part of FIRESAFE II (EMSA, 2018)), this RCO was considered to significantly affect the potential for fire spread by a possibility to cool surfaces of the accommodation, closed/open ro-ro space or other adjacent part of the ship. On *Ferry RoPax*, where there is a quite small weather deck and hence a relatively large part of the weather deck perimeter connects adjacent parts of the ship This RCO was therefore expected to have significant impact on the potential for failure due to flame and heat spread on *Ferry RoPax*, and slightly less due to smoke spread. It should be noted that potential effects from the wind direction should not be considered at this stage. For *Standard* and *Cargo RoPax*, the relative area of the weather deck close to adjacent parts of the ship is a little lower than for *Ferry RoPax*. Weather deck containment failure due to flame, heat and smoke spread were estimated to be of

similar magnitude on these ships. In total, considering a 90% RCO reliability, the impact on the failure probability was estimated to:

- 80% reduction in failure of fire containment due to flame or heat spread from weather deck on *Ferry RoPax* ships;
- 70% reduction in failure of fire containment due to smoke spread from weather deck on *Ferry RoPax* ships;
- 65% reduction in failure of fire containment due to flame or heat spread from weather deck on *Standard RoPax* and *Cargo RoPax* ships.
- 65% reduction in failure of fire containment due to smoke spread from weather deck on *Standard RoPax* and *Cargo RoPax* ships.

The affected nodes, the risk reduction potential for the containment RCO Fire monitors and affecting factors are summarized in Table 37 for Cargo RoPax ships, in Table 36 for Standard RoPax ships and in Table 38 for Ferry RoPax ships.

Table 36: Reduction of failure probability for containment nodes impacted by considered RCO for *Standard RoPax*

RCO	Affected nodes	Affecting factors	Closed		Open		WD
			Suc	Unsuc	Suc	Unsuc	
Fire monitors on weather deck	Failure of fire containment - Flame spread through openings - Openings	Adjacent ro-ro space, successful extinguishment, reliability, positioning of fire monitors.	0%	0%	78.75%	78.75%	-
	Failure of fire containment - Heat spread - Failure of boundary cooling	Adjacent ro-ro space, successful extinguishment, reliability, positioning of fire monitors.	4.5%	4.5%	45.0%	45.0%	-
	Failure of fire containment - Flame spread	Proportion of WD area close to adjacent parts of the ship to which fire may spread, such as accommodations or ro-ro space.	-	-	-	-	65%
	Failure of fire containment - Heat spread	Proportion of WD area close to adjacent parts of the ship to which fire may spread, such as accommodations or ro-ro space.	-	-	-	-	65%
	Failure of smoke containment - Smoke spread	Proportion of WD area close to adjacent parts of the ship to which smoke may spread, such as accommodations or ro-ro space.	-	-	-	-	65%

Table 37: Reduction of failure probability for containment nodes impacted by considered RCO for *Cargo RoPax*

RCO	Affected nodes	Affecting factors	Closed		WD
			Suc	Unsuc	
Fire monitors on weather deck	Failure of fire containment - Flame spread through openings - Openings	Adjacent ro-ro space, successful extinguishment, reliability, positioning of fire monitors.	87%	72%	-
	Failure of fire containment - Heat spread - Failure of boundary cooling	Adjacent ro-ro space, successful extinguishment, reliability, positioning of fire monitors.	30%	30%	-
	Failure of fire containment - Flame spread	Proportion of WD area close to adjacent parts of the ship to which fire may spread, such as accommodations or ro-ro space.	-	-	65%
	Failure of fire containment - Heat spread	Proportion of WD area close to adjacent parts of the ship to which fire may spread, such as accommodations or ro-ro space.	-	-	65%
	Failure of smoke containment - Smoke spread	Proportion of WD area close to adjacent parts of the ship to which smoke may spread, such as accommodations or ro-ro space.	-	-	65%

Table 38: Reduction of failure probability for containment nodes impacted by considered RCO for *Ferry RoPax*

RCO	Affected nodes	Affecting factors	Closed		WD
			Suc.	Unsuc	
Fire monitors on weather deck	Failure of fire containment - Flame spread through openings - Openings	Adjacent ro-ro space, successful extinguishment, reliability, positioning of fire monitors.	82%	86%	-
	Failure of fire containment - Heat spread - Failure of boundary cooling	Adjacent ro-ro space, successful extinguishment, reliability, positioning of fire monitors.	4.5%	4.5%	-
	Failure of fire containment - Flame spread	Proportion of WD area close to adjacent parts of the ship to which fire may spread, such as accommodations or ro-ro space.	-	-	80%
	Failure of fire containment - Heat spread	Proportion of WD area close to adjacent parts of the ship to which fire may spread, such as accommodations or ro-ro space.	-	-	80%
	Failure of smoke containment - Smoke spread	Proportion of WD area close to adjacent parts of the ship to which smoke may spread, such as accommodations or ro-ro space.	-	-	70%

10.6 Estimation of Risk Reduction by the implementation of RCOs

The above quantifications of the selected containment RCOs were integrated into the main fire risk model, from which effects on the total risk could be calculated. The relative risk reductions of the selected containment RCOs for each of the generic ships are presented in Figure 37 for Newbuildings and in Figure

38 for Existing ships. The results are presented in terms of relative risk reductions to standardize the impact (reduction) of the RCO on the PLL, which is different for the three generic ships for example depending on their varying passenger capacity

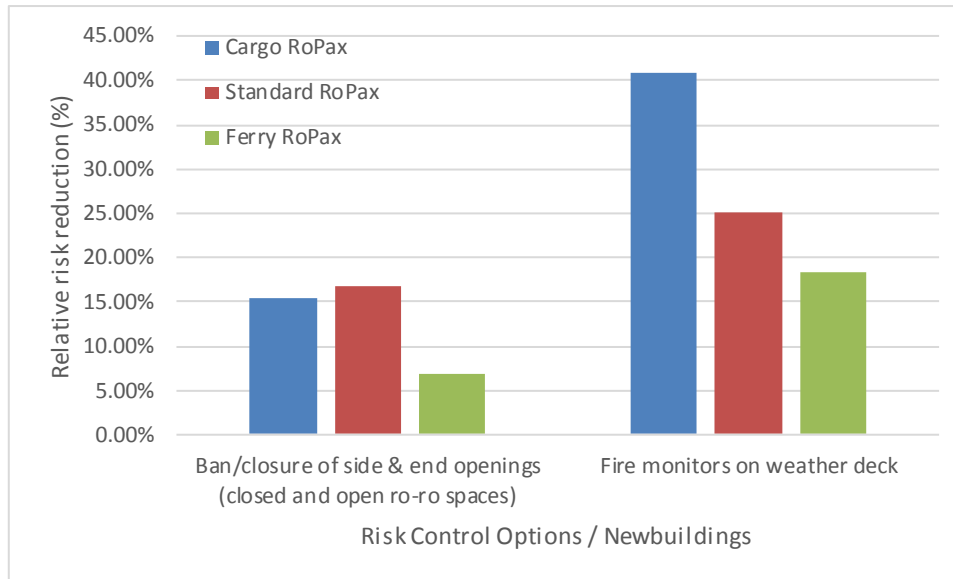

Figure 37: Relative Risk Reduction of Containment RCOs for Newbuildings

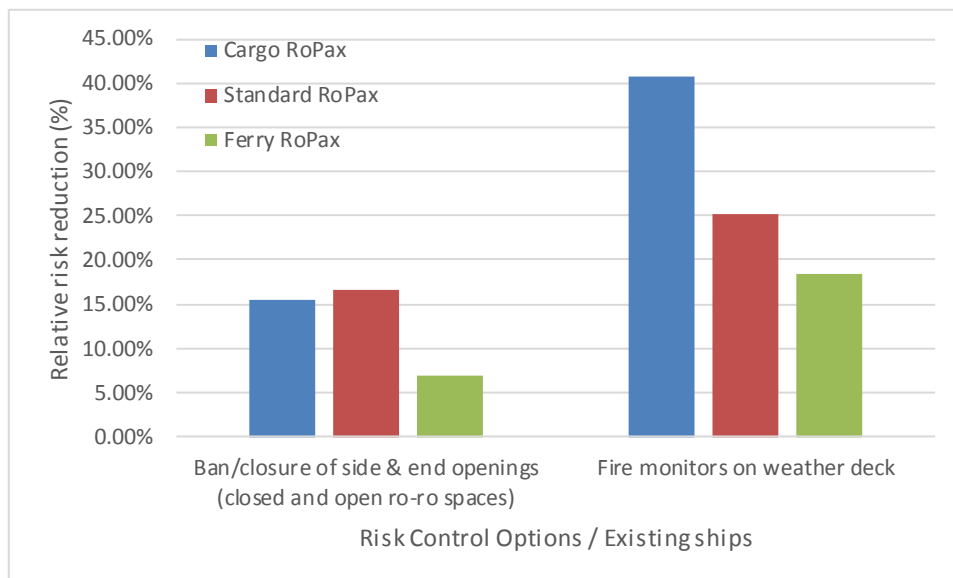

Figure 38: Relative Risk Reduction of Containment RCOs for Existing Ships

Regardless of ship category and status (i.e. Newbuildings vs. Existing ships), the RCO with the highest risk reduction potential is the RCO *Fire monitors on weather deck*. The high figure for the *Cargo RoPax* (approximately 40% of relative risk reduction) is mainly due to the significant size of the weather deck and relative small size of the garage (implying a high chance of flame spread if a fire occurs in this part – fire monitors will significantly reduce this risk).

On the *Cargo RoPax* and *Standard RoPax*, the RCO *Ban/Closure of side & end openings* also proves to have a significant risk reduction potential with around 15% of relative risk reduction. These figures apply for Newbuildings but the general results are the same for Existing ships.

On the *Standard RoPax*, although one could have expected that the RCO *Ban/Closure of side & end openings* would have the highest risk reduction potential for a containment point of view, it should be noted

that this RCO has a low impact on the containment failure following a fire occurring on the weather deck – contrary to the RCO *Fire monitors on weather deck*.

It should be noted that the relative risk reductions presented and discussed above only take into account the effects of the respective RCOs on the Containment node in the main fire risk model event tree. However, any effects that the RCOs could have directly on the other main branches of the main fire risk model event tree (e.g. more likely extinguishment from *Fire monitors on weather deck*) were disregarded in this part of the study and were instead further studied in the Combined Assessment part of the FIRESAFE II study (EMSA, 2018).

11 RISK CONTROL OPTIONS – EVACUATION

To propose effective and practical risk control options (RCOs) for further evaluation, the following stages were considered:

- Focus on risk areas requiring control;
- Identification of potential risk control measures (RCMs);
- Evaluation of the effectiveness of the RCMs; and
- Grouping of RCMs and selection of suitable RCOs for further cost-effectiveness analysis (CEA).

Evacuation in the event of fire in ro-ro spaces is very important for the safety of passengers. Evacuation may fail in many ways, identified in a hazard identification workshop (see section 8.2 Hazard Identification – Evacuation) where risk control measures were also identified. Structured analysis in several workshops comprising experts from fire research, classification society and industry led to the selection of a limited number of RCOs, evaluated in further detail.

11.1 Identification of RCOs

Based on 9.4.2 and Table 28, one RCO ensuring safe evacuation on RoPax ships was identified and defined as a design with:

- A [13 m] safety distance between LSA embarkation stations and weather deck/ro-ro space aft openings.
- An [8 m] safety distance between stowed LSAs (including survival craft, not embarked onboard) and weather deck/ro-ro space aft openings
- No LSAs or embarkation station within the full vertical range 6 m forward and aft of a side opening larger than 0.01 m².

As highlighted in the conclusion of paragraph 9.4.1.1.2.1, the 8 m and 13 m criteria proposed are sensitive to the ship design and were estimated as additional outputs of the study for the purpose of calculating the risk associated with evacuation failure as accurately as possible. The proposed safety distance would benefit from being discussed with regard to the assumed critical conditions for LSAs and humans as well as the critical assumptions made for the heat exposure simulations and calculations.

As part of the study, four different ways of achieving this RCO were investigated. The RCO was named “safe distance” and the four different ways to achieve this were identified as:

Evac 1a: Closure of significant openings;

Evac 1b: Closure of all side openings;

Evac 1c: Closure of openings near LSAs (including embarkation station); and

Evac 1d: Moving the LSAs.

11.2 Detailed description of RCO applied to generic ships

This section contains a detailed description of the measures identified and selected in the pre-screening process.

The three first ways of achieving a safe distance involve closure of openings, only with a difference in the extent of such measures. Furthermore, the application of the measures is dependent on the type of RoPax ship. Some brief descriptions are therefore given here on what each measure entails in practice and to what ships they apply, as summarized in Table 39.

The measures involving *closure of side openings* and *closure of openings near LSAs* are only applicable for the *Standard RoPax*, whereas *Closure of significant openings* is applicable for all RoPax ship types. The term “significant” was used to highlight that the relevant openings for the measure in question depend on the type of RoPax ship being examined. For the *Ferry RoPax* and the *Cargo RoPax*, only the aft opening was considered significant to close to protect the LSAs, and for the *Standard RoPax* “significant” includes the aft

opening as well as all side openings. The relevant variations of Evac1 for the different ship types and the extent of RCM Evac 1a is summarized in Table 39.

Table 39: Variations of evacuation RCO relevant for the different generic RoPax ships

Ship type\RCM	Evac 1a (significant)	Evac 1b (sides)	Evac 1c (near LSA)	Evac 1d (move LSA)
Standard	X (Close all side openings and aft opening)	X	X	-
Ferry	X (Close aft opening)	-	-	X
Cargo	X (Close aft opening)	-	-	-

Even though there may be minor side openings for closed ro-ro spaces of the *Ferry RoPax* and *Cargo RoPax*, these openings are limited in size and number and were as a result not considered to let out enough smoke or flames for LSAs to be impacted in the event of a fire.

For the *Ferry RoPax*, fire in closed ro-ro space near the aft opening would lead to flames extending on Deck 5, exposing nearby LSAs to heat from radiation and smoke. Closure of the aft opening will thus reduce the probability of LSAs being impacted by smoke and radiation from flames. For the *Cargo RoPax* it was concluded that LSAs will not be impacted by radiation from flames, even if the fire extends on Deck 4, as the location of LSAs relative to the opening is not within their safety distance. There will however be an impact on LSAs from smoke whenever the fire is on the weather deck or in the closed ro-ro space with an aft opening and the wind direction is towards the LSAs. Closing the aft opening for the *Cargo RoPax* will thus, to a certain extent, reduce the probability for evacuation failure.

All the first three RCOs provide, broadly speaking, the same benefit, i.e. a smaller total opening area reduces the probability for smoke and flames to affect evacuation. The RCMs will however differ regarding their associated effectiveness depending on the type of RoPax ship. As presented in Table 39, closing all side openings or closing side openings near LSAs will not be effective measures for the *Ferry RoPax* or *Cargo RoPax* since these ways of achieving a safe distance are not applicable for these ships. On the other hand, closing all significant openings will be an effective measure for all three RoPax types, although the degree of effectiveness will vary depending on the type of RoPax ship.

Regarding *Standard RoPax*, permanent closure of side openings also has other positive effects not directly associated with evacuation, e.g. slower fire development, increased chances for early detection due to less airflow which affects heat and smoke movement, and increased probability of a successful extinction or suppression by the drencher system. However, it also entails new costs for installing a ventilation system, limitations in cargo intake (dangerous goods) and was for example considered to increase the probability for internal smoke spread (cf. closed ro-ro space).

11.2.1 Closure of all significant openings

For *Standard RoPax*, significant openings refer to side openings and aft opening. For the *Ferry RoPax* and *Cargo RoPax* significant openings refer only to the aft opening.

11.2.1.1 Benefits

Closing all significant openings will have an impact on all RoPax ship types. The largest benefit will be that smoke and flames will be contained to a higher degree, reducing the probability for evacuation failure. For the *Standard RoPax*, the practical benefits would not be different from closing all side openings, discussed below. There is however an increased cost associated with this RCM since it also includes closure of the aft opening. With respect to *Cargo RoPax* and *Ferry RoPax*, closing all significant openings would have an impact in the sense that smoke and flames from fires inside the closed ro-ro space near the aft opening will be blocked from exiting through the aft opening, hence removing the probability for LSAs being impacted.

11.2.1.2 Critical aspects

In addition to the critical aspects described in section 12.2.1.1.2 regarding the *Standard RoPax*, closure of the opening in the aft may have a negative impact on the cargo carrying capacity of the ship. It is worth noting that all offered solutions for closing devices related to the aft opening come without door for access, the implication being that when the device is closed there will be no opening for fire patrolling or for fire party to access the weather deck without opening the shutter.

For the *Ferry RoPax* the shape of the deckhead makes a reconstruction necessary, which ultimately reduces cargo capacity on weather deck.

Closing the aft opening for the *Standard RoPax* means that 12 m of the weather deck would not be open from above and will subsequently likely not be approved by the pertinent authority as a weather deck, which affects the ship capacity for certain types of cargo.

11.2.2 Permanent closure of all side openings

Potentially, both open and closed ro-ro spaces have openings that could be closed. This measure focuses on the portside and starboard side openings of open ro-ro spaces.

For Existing ships, this measure consists in the closure of the existing permanent side openings (portside and starboard side) as far as practicable. Concerning Newbuildings, this RCO results in that only open ro-ro space designs with two end openings will be possible.

11.2.2.1 Benefits

Closing all side openings only pertains to the *Standard RoPax* ship. As there will be no side openings, the likelihood for smoke and heat to exit through the sides and consequently impact LSAs will be reduced to zero. In case of a fire scenario near the aft opening of the open ro-ro space, smoke coming from the aft opening essentially corresponds to smoke from a fire on weather deck on Deck 4. This scenario was previously determined to not be associated with evacuation failure due to the superstructure impeding the smoke, thus generating turbulence and consequently intensifying the dispersion of smoke and avoiding evacuation failure in case of a wind towards LSAs.

11.2.2.2 Critical aspects

Closure of openings on Existing ships will imply that increased mechanical ventilation capacity is required, which could lead to a rather extensive and costly installation. That would also lead to increased fuel consumption, since additional power supply is needed. If additional power is not available, it will mean installation of auxiliary engines for power supply. This is costly, technically challenging and likely to affect cargo carrying capacity.

Due to restrictions regarding e.g. carrying dangerous goods in closed ro-ro spaces, an additional critical aspect would be potential loss of cargo. Commercially this could also affect customers to choose a different route, ship or company for all of its cargo and this means that the ship owner does not only lose the dangerous goods cargo but potentially also important customers and market shares.

11.2.3 Permanent closure of side openings near LSAs

Closing side openings near LSAs would impact the probability for LSAs being affected by smoke or flames. The RCO is only applicable for *the Standard RoPax* because it has, unlike the *Ferry* and *Cargo RoPax*, open ro-ro space with large side openings near LSAs.

11.2.3.1 Benefits

Closing side openings near LSAs only pertains to the *Standard RoPax*. As there will be no side openings within the safety distance, radiation from flames near LSAs can be dismissed. This means that the only mode of failure is due to smoke, which is dependent on wind direction. Relative to the other RCMs which also involve closure of openings, this RCM is more viable in terms of required effort and work, as reflected in the cost of the measure.

11.2.3.2 Critical aspects

If the ship is to maintain its cargo carrying capacity the ro-ro space must remain open and new side openings are likely required. For every closed opening, a new opening must hence be created. No effects on the definition of the space or related aspects such as the ventilation system were hence assumed.

11.2.4 Moving the LSAs

Moving the LSAs implies moving them away from ro-ro space openings, to ensure that the safety distance is achieved.

11.2.4.1 Benefits

The benefits of moving LSAs are similar to those described for closing side openings near LSAs, i.e. the impact from flames and smoke will be limited if LSAs are moved away from openings.

11.2.4.2 Critical aspects

The available space on the vessel that can accommodate LSAs is limited. If LSAs are to be moved, there has to be alternative stowage areas for LSAs available that are more appropriate from a safety point of view. As the current regulations are not fully clear and thus open for different interpretations, no or limited effort is generally put into designing ships with LSAs in mind, which strongly restricts alternative stowage areas for survival craft on Existing ships. The measure is therefore often impractical for operators of Existing ships. For newbuildings, this way to achieve the RCO was considered to be most likely to apply, potentially with a redesign of the openings (Evac 1c).

11.3 Selected measures

The first three identified measures were selected for further cost-effectiveness analysis. Hence, RCM Evac 1d was not selected, mainly due to the uncertain costs and feasibility associated with this safety measure.

11.4 Technical Specifications of measures

11.4.1 Closing all significant openings

This risk control measure implies to forbid open ro-ro spaces on new ships. Ro-ro spaces are defined as open if it has two open ends or one end with at least 10% openings provided in the sides of the ship (SOLAS II-2/3.12). Hence, closed ro-ro spaces can have quite significant openings and both open and closed ro-ro spaces have openings which could need to be closed based on this RCM. It includes closing all the ro-ro space side openings (port side, starboard side, and aft) which could have impact on evacuation.

Openings in the sides of the ship were in this RCM assumed to be welded shut on Existing ships and omitted on in the design of newbuildings, making the spaces permanently and fully enclosed. The fire integrity of the covered openings should achieve the same requirements as the rest of the division, which towards external areas or open deck generally is A-0, in accordance with SOLAS II-2/9. This implies a non-combustible structure which is constructed to prevent the passage of smoke and flame for 60 minutes, but which may conduct heat momentarily.

Except from closing the ship side openings as far as practicable, the end openings need to be closed. This may be achieved in any way, for example by a roller shutter, gate or ramp, as long as it is certified for marine use (Wheel Mark) and achieves suitable fire integrity requirements. The purpose of the closing device is to avoid fire spread and achieve containment for the ro-ro space to which it is installed. Based on the maritime regulatory framework, the most relevant requirement for end closing devices appears to be A-0, but this could be a bit conservative and difficult to achieve for a suitable device. The most important functions are avoidance of flame spread and minimization of smoke spread. It is relevant to require the division to be constructed of non-combustible material.

In addition to the above specifications, means will need to be provided to fulfil regulations with regard to ventilation of the ro-ro space, in particular if closing an existing open ro-ro space. Such a ventilation system will need to achieve relevant regulations in SOLAS II-2/20 and could imply significant additional costs and installations to account for the increased requirement for ventilation. Furthermore, it must be made sure that the closed openings (primarily end opening devices) do not block other important functions, such as fire patrols, drainage, detection system, drencher system, etc.

This measure has different application for the different types of ships considered, summarized as:

- *Standard RoPax*: closure of all side openings and aft opening;
- *Ferry RoPax*: closure of aft opening; and
- *Cargo RoPax*: closure of aft opening.

11.4.2 *Closing all side openings*

This risk control measure also implies to forbid many of the open ro-ro spaces on new ships, since no side openings will be allowed (port side and starboard side openings – aft openings will be allowed). Ro-ro spaces are defined as open if it has two open ends or one end with at least 10% openings provided in the sides of the ship (SOLAS II-2/3.12). Hence, only ro-ro spaces with two open ends will be possible as open ro-ro spaces. Closed ro-ro spaces can also have quite significant side openings and hence both open and closed ro-ro spaces have side openings which could need to be closed based on this RCM. It includes closing all ro-ro space side openings (port side and starboard side, not aft).

Openings in the sides of the ship were in this measure assumed to be welded shut on Existing ships and omitted on in the design for newbuildings, making the spaces permanently closed. The fire integrity of the covered openings should achieve the same requirements as the rest of the division, which towards external areas or open deck generally is A-0, in accordance with SOLAS II-2/9. This implies a non-combustible structure which is constructed to prevent the passage of smoke and flame for 60 minutes, but which may conduct heat momentarily.

In addition to the above specifications, means will need to be provided to fulfil regulations with regard to ventilation of the ro-ro space, in particular if closing an existing open ro-ro space, which was assumed for this measure. Ventilation systems need to achieve relevant regulations in SOLAS II-2/20 and could imply significant additional costs and installations to account for the increased requirement for ventilation. Furthermore, it must be made sure that the closed openings (primarily end opening devices) do not block other important functions, such as fire patrols, drainage, detection system, drencher system, etc.

11.4.3 *Closing side openings near LSAs*

This risk control measure does not imply to forbid open ro-ro spaces. Despite the requirement that openings to the open ro-ro space should be distributed along the side of the ship, this RCM entails to forbid side openings (port side and starboard side openings – aft openings will not be considered) within the safety distance of LSAs and embarkation stations. Only critical side openings will hence be removed, and they may need to be replaced by new openings on Existing ships in case the area of the openings is just above 10% of the total area of the space sides. On the selected generic *Standard RoPax* ship (the only ship with an open ro-ro space), four openings would need to be moved. On Newbuildings it was considered possible to account for this change in the design of the ship. No re-definition or prohibition of open ro-ro spaces were thus considered and no resulting impacts on ventilation system, cargo intake, etc.

Openings in the sides of the ship were in this RCM assumed to be welded shut on Existing ships and moved at the design stage for newbuildings. The fire integrity of the covered openings should achieve the same requirements as the rest of the division, which towards external areas or “open deck” generally is A-0, in accordance with SOLAS II-2/9. This implies a non-combustible structure which is constructed to prevent the passage of smoke and flames for 60 minutes, but which may conduct heat momentarily.

11.5 Quantification of evacuation RCO effectiveness

11.5.1 *Closing all significant openings*

The effect of achieving the evacuation RCO by closing “significant” openings (potentially including portside and starboard side openings as well as aft opening) is quantifiable for all ship types. It implies that there will no longer be any open ro-ro space on the *Standard RoPax* ship, it will become a closed ro-ro space, and the end results is the same for all three ship types: there will be no aft or portside/starboard side openings for any of the ships. Thereby, no flame spread from portside and starboard side openings will impede the LSAs and no smoke spread from the aft opening will impede evacuation, regardless of wind.

For the *Standard RoPax* ship, this way of achieving a safe distance implies that the probability of evacuation failure due to fire in the open (now closed) ro-ro space was reduced from 65% to 0%. However, changing the open ro-ro space to a closed ro-ro space will also impact other parts of the risk model, for example the potential for loss of containment due to internal smoke, the potential for detection, etc., considered in the combined assessment (EMSA, 2018). Smoke from a fire on weather deck may nevertheless still impact the LSAs in case of an unfortunate wind direction and cause evacuation failure in the model.

For the *Ferry RoPax* ship, this way of achieving a safe distance implies that no flame spread nor smoke will affect the LSAs. The probability of evacuation failure due to fire in the closed ro-ro space in front of the weather deck was reduced from 39% and 11%, for scenarios with unsuccessful and successful suppression respectively, to 0% for both scenarios. However, it should be noted that fires on weather deck may in the model still cause evacuation failure due to both heat radiation from the fire (since LSAs are within the safety distance) and due to smoke in case of an unfortunate wind direction.

For the *Cargo RoPax* ship, this way of achieving a safe distance implies that smoke spread to the LSAs in case of wind towards the LSAs is no longer possible. However, since the LSAs are already at a safe distance from the openings in the original design, there is no reduction in the probability for flame spread to LSAs (it is already 0%). The probability of evacuation failure due to smoke originating from a fire in the closed ro-ro space in front of the weather deck was reduced from 5.1% to 0%. Smoke from a fire on weather deck may nevertheless still impact the LSAs in case of an unfortunate wind direction and cause evacuation failure in the model.

In addition to the figures noted above, the intrinsic evacuation failure probability of 36% was added (with consideration to that fire and intrinsic failures can occur simultaneously).

11.5.2 *Closing all side openings*

The effect of achieving the evacuation RCO by closing all side openings (portside and starboard side, not aft) is only quantifiable for the *Standard RoPax* ship. It implies that there will no longer be any open ro-ro space, it will become a closed ro-ro space, but the aft opening will be left open. Flame spread from the openings of the open ro-ro space will not impede the LSAs and smoke spread from the aft opening was neither considered to impede evacuation, regardless of wind. Hence, the probability of evacuation failure due to fire in the open ro-ro space was reduced from 65% to 0%.

In addition to the figure above, the intrinsic evacuation failure probability of 36% was added (with consideration to that fire and intrinsic failures can occur simultaneously).

11.5.3 *Closing side openings near LSAs*

The effect of achieving the evacuation RCO by only closing openings near LSAs is only quantifiable for the *Standard RoPax* ship. It implies that there will no longer be any critical zone but that the whole open ro-ro space will be a partially critical zone. Hence, flame spread from openings for the open ro-ro space will not impede the LSAs, but it is still possible that smoke from openings in the partially critical zone will impede evacuation in case of wind in the direction of the LSAs. Hence, the probability of evacuation failure due to fire in the open ro-ro space was reduced from 65% to 25% (for calculation details, see 9.4.3.3.1).

In addition to the figure above, the intrinsic evacuation failure probability of 36% was added (with consideration to that fire and intrinsic failures can occur simultaneously).

11.6 Estimation of Risk Reduction by the implementation of the RCO

The above quantifications of the different ways investigated to implement the RCO safe distance were integrated into the main fire risk model, from which effects on the total risk could be calculated. The relative risk reductions of the investigated ways to achieve the RCO for each of the generic ships are presented in Figure 37 for Newbuildings and in Figure 38 for Existing ships. The results are presented in terms of relative risk reductions to standardize the impact (reduction) on the PLL, which is different for the three generic ships for example due to different effects (described above) and depending on their varying passenger capacity.

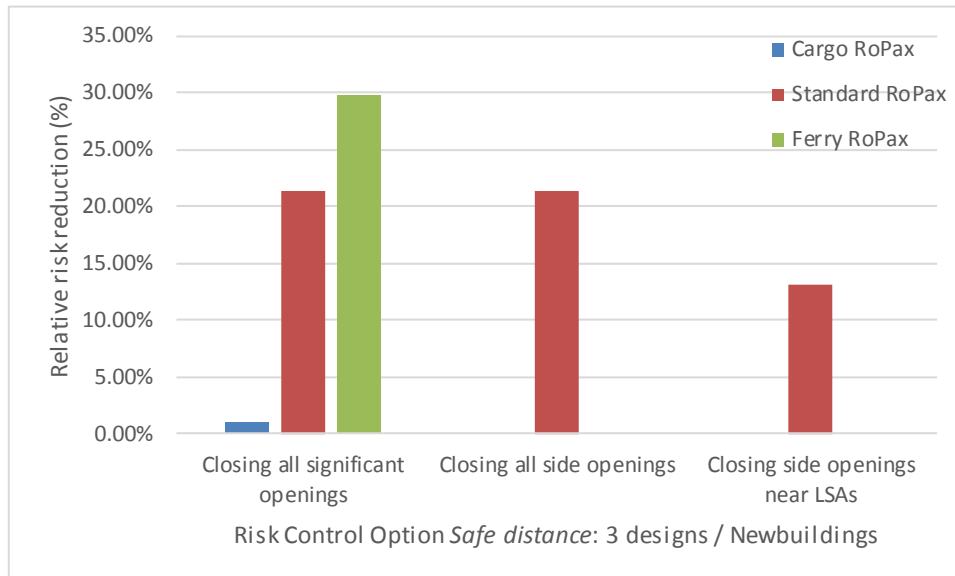

Figure 39: Relative Risk Reduction of the three designs investigated for the RCO *Safe distance* for Newbuildings

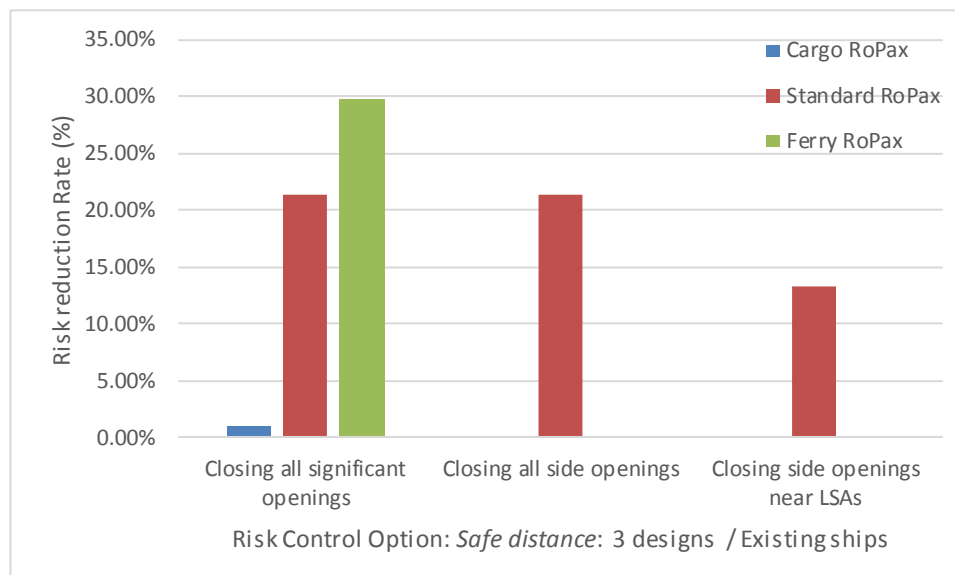

Figure 40: Relative Risk Reduction of the three designs investigated for the RCO *Safe distance* for Existing Ships

All the results are independent of the ship status (i.e. Newbuildings vs. Existing ships). The design *Closing all side openings* is the only design applicable to the three ship categories.

On the *Ferry RoPax*, this design reduces significantly the risk of evacuation failure with a risk reduction rate reaching approximately 30%. This is mainly due to the closing of the aft opening of the closed ro-ro spaces, impeding smoke spread towards the embarkation station located just above the opening.

On the *Cargo RoPax*, the risk of stowage areas, embarkation stations, evacuation routes and LSA failure due to heat was limited (occurring with a low probability only following an unsuppressed, uncontained fire in the garage). Therefore, the design achieves only a fairly small risk reduction rate.

For the *Standard RoPax*, the designs *Closing all side openings* and *Closing all significant openings* achieve the same risk reduction rate (21.4%). However, the design *Closing side openings near LSAs* shows a lower risk reduction rate due to the fact that smoke can still spread through some openings and impact the LSAs and embarkation stations.

It should be noted that the relative risk reductions presented and discussed above only take into account the effects of the RCO on the Evacuation node in the main fire risk model event tree. However, any effects that the RCO could have directly on the other main branches of the main fire risk model event tree (e.g. improved containment) were disregarded in this part of the study and were instead further studied in the Combined Assessment part of the FIRESAFE II study (EMSA, 2018).

12 COST-EFFECTIVENESS ASSESSMENT

12.1 Cost-effectiveness assessment – background

The background and assumptions of the cost-effectiveness assessment were provided in the report for Part 1 of the FIRESAFE II study (EMSA, 2018), while the main information is summarized below.

It was proposed to use 7 000 000€ as the cost effectiveness criterion in FIRESAFE II. The expected lifetime (T) of a RoPax ship was set to 40 years, whereas the average age of the fleet was estimated to 20 years. The delta cost and benefits were calculated in Net Present Value (NPV) with a depreciation rate of 3.5% for the period of years 1 – 30 and 3.0% for the period of years 31 – 40 (HM Treasury, 2018).

12.2 Estimation of costs

This cost identification has been done in cooperation with relevant manufacturers and Stena's internal resources which includes conversion experts, ship's crew, ship's technical superintendent, and fleet managers.

12.2.1 RCO Containment – Ban/closure of side & end openings

This Risk Control Option is applied to all generic ships studied. The cost details of the proposed measures for the three RoPax are summarized in Table 40 for Existing ships, and Table 42 for newbuildings.

12.2.1.1 Existing ships

For the *Standard RoPax*, this RCO involves closing the large side openings on Deck 4 which, according to the current regulations, is defined as an open ro-ro space.

For RoPax with only closed ro-ro spaces and weather decks (but no open ro-ro spaces), i.e. *Cargo RoPax* and *Ferry RoPax*, the closure of openings means adding an aft closing device close and closing minor openings in the side.

12.2.1.1.1 Cargo RoPax

The *Cargo RoPax* has two larger side openings on port side and several minor openings on starboard side that will need to be closed. The closed ro-ro space that is connected to a weather deck via one large opening in the aft will by the same token need to be closed by means of a closing device. The required free height for cargo is however limiting the type of closure that is feasible. A side folded wall could technically be possible but has been disregarded for safety and operational reasons. To fit a roller shutter above the opening, the aft part of the deck head above needs to be modified slightly to accommodate for the roller barrier. Figure 41 and Figure 42 present examples of aft opening and side openings respectively for the *Cargo RoPax*.

Costs for closing the aft opening have been regarded in terms of: added exhaust ventilation capacity, steel work and steel which amounts to approximately 2 tonnes for the openings, one roller shutter b x h 16.5 x 4.9 m, scupper, as well as a yearly cost for operating fans.



Figure 41: *Cargo RoPax* from the aft. Slight adjustments to the opening and the roll will be located just above the opening



Figure 42: Left picture: *Cargo RoPax* bigger openings port side that needs to be closed. Right picture: starboard side at the same location

12.2.1.1.2 Standard RoPax

Closing side openings

The *Standard RoPax* has an open ro-ro space which per the applicable measure will be closed. Closing side openings is not an easily accommodated modification to ships designed with such openings. The associated costs for such procedures were investigated in the first part of FIRESAFE II (EMSA, 2018). Performing the cost estimation on more than one ship, it was acknowledged that closing side openings may vary greatly depending on ship, and it was recommended to look at a price range rather than an example price for one specific ship when assessing these measures.

The base figure for closing the side (portside and starboard) openings derived in Part 1 of FIRESAFE II, will nonetheless be used as the basis for this RCO which includes closing side and aft openings. For vessels with open ro-ro spaces, the ventilation system is not designed to cope with an extra deck and the auxiliary power unit may not be able to provide the required energy for the increased mechanical ventilation needs. Added reefer sockets may furthermore drive cost and auxiliary power need. In general, any future additional installation such as for example scrubber installation will need additional auxiliary engine installation. Closing the side openings makes the decks defined as closed spaces as per SOLAS definition.

In addition to the above, the ship owner will experience loss of cargo (e.g. reducing amount of IMDG cargo), and additional operational costs due to the closing of the side openings. These costs have been estimated for these ships and would recur yearly throughout the ship's remaining lifetime.

Another operational issue is that the changed cargo certificate may make the ship less attractive on the route it serves. Cost for closing side openings has been regarded in terms of:

- Material and closing work
- Ventilation capacity and operating cost
- Power availability; enough power installed (to cope with ventilation demand and electrical connections for cargo)
- Deck definition and closing device
- Cargo situation changes

Closing aft opening

The aft opening on the *Standard RoPax* is a large opening at frame 15 that is fairly far aft of the closed ro-ro space. It is divided by a centre casing, thus requiring two closing devices. One of the devices will extend further down than the other due to the ramp that is positioned at a lower level than the normal Deck 4 level (cf. Figure 43).

The different arrangements warranted separate solutions for starboard and port side respectively. On starboard side a hinged door installed on the centre casing was determined to be the best viable option, whereas a roller shutter mounted below deckhead was the preferred solution for the port side of the aft opening. This setup would not interfere with the free height for cargo, nor would it obstruct the lanes when unfolded. Interference with free height is particularly critical for these vessels, which is why a side mounted solution had to be chosen for the starboard side (cf. Figure 44).

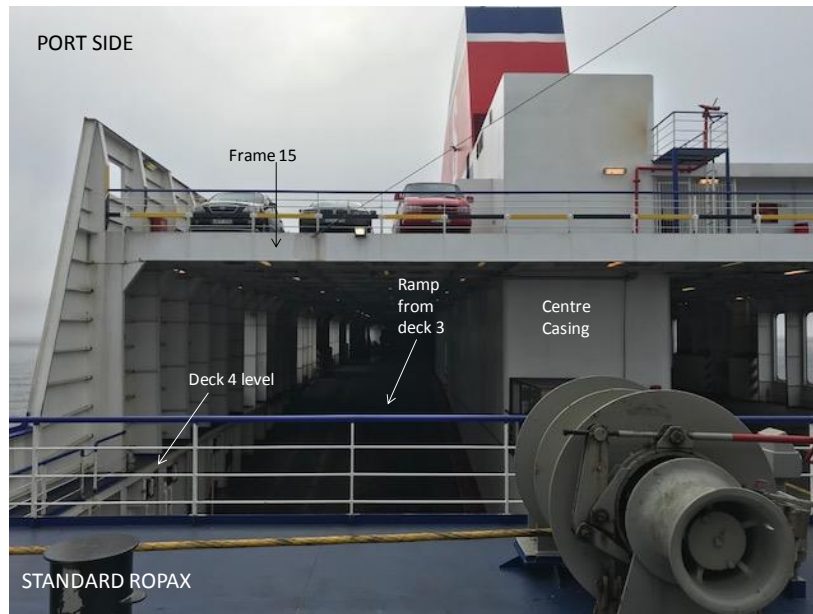

Figure 43: Picture showing *Standard RoPax* opening port side from the aft. It is worth noting the ramp down to deck 3.

Furthermore, although interference with the lanes (the case for folded walls for example) could technically be accepted, it is to be avoided for various reasons, including personnel safety during cargo operations, from a loss of cargo-perspective and from a delayed cargo handling perspective.

The roller shutter (and door) is of European standard class A1, meaning it is not marine standard classified. It is not smoke tight but minimizes passage of gases and it is made of fire proof material. They are required to be located 12 m in under deckhead, which leaves 22 m deck aft of the door for cargo stowage. This means that 12 m of the weather deck will not be open from above and may as a result not be approved as weather deck. If this modified design is deemed uncompliant, the vessel will lose its capability to carry dangerous goods since the second weather deck on the upper level is only for low cargo such as personal cars. This must be assessed by authorities and could not be determined in this study. For the sake of this study, it has been assumed that these aft closing devices can be fitted and that the installation concept will be approved by authorities. In its current form, the weather deck is partly covered but in connection with an open ro-ro space with natural ventilation and a different assessment could be required when the deck is redefined as a weather deck in connection with a closed deck. One shall further note that adding closing devices is not easily accommodated unless already built in during construction. It was nonetheless assumed that it can be done during a normal docking.

For the *Standard RoPax*, the items considered are: added ventilation capacity, material and work for 30 closed openings 6 m² each, approximately 15 tonnes of steel, one roller shutter b x h 10 x 6 m including steelwork and installation, one hinged door including steelwork and installation, scupper, as well as a yearly cost for the loss of cargo capacity and for operating fans.



Figure 44: Picture showing *Standard RoPax* opening starboard side from the aft.

This *Standard RoPax* has a sister vessel which was also investigated even though she is not part of the study. The purpose of this section is to show the variations between the ships within the context of closing the aft opening. The *Standard RoPax* aft opening is divided into two openings by a centre casing. The port side opening has a suitable flat and straight aft end above it, which would be ideal for a roller shutter, but it does not have full width to cover the opening (see Figure 45 port side frame 36).

The centre casing, at deckhead level, is protruding out over the opening. It has been assumed that it can be reconstructed and still fit the roller shutter, but this could not be verified without further investigation. One possible solution is to have a folded wall, but since the system would be in the middle of the fixed ramp such a solution would be deemed impractical. The starboard side opening can be fitted with the roller shutter and roll above the opening, but in this case, there is no side to close it to, see Figure 45. In this picture, the odd shape of the side can also be noticed. This would require reconstruction most likely by adding steel plate to the starboard side wall next to the opening, granted it is allowed by authorities.



Figure 45: Picture showing *Standard RoPax* sister vessel openings from the aft.

12.2.1.1.3 Ferry RoPax

Deck 4 of the *Ferry RoPax* consists of a closed ro-ro space connected to a weather deck via an open aft that is divided by a centre casing, thus requiring two closing devices in the form of roller shutters mounted on the aft side of the opening.

The shape of the deckhead requires reconstruction in order to fit the roller shutters as there is no straight line at the aft end opening, but rather a line shaped liked a wing. The procedure involves extending the deckhead and creating a straight line at frame 36. Picture of the weather deck is provided in Figure 46. This will also require a small cut out in the deckhead plating on the sides, as illustrated by Figure 47. Surfaces marked in red refer to added deck whereas blue markings refer to removed plating. The deck 7 aft will be extended 5 m and additional detection and drencher components are expected to be added in this section.

The proposed solution has been assumed possible, with an apparent downside in the sense that it reduces cargo capacity on weather deck, affecting stowage arrangement resulting in the loss of 4 units per voyage, which in economic terms is substantial.

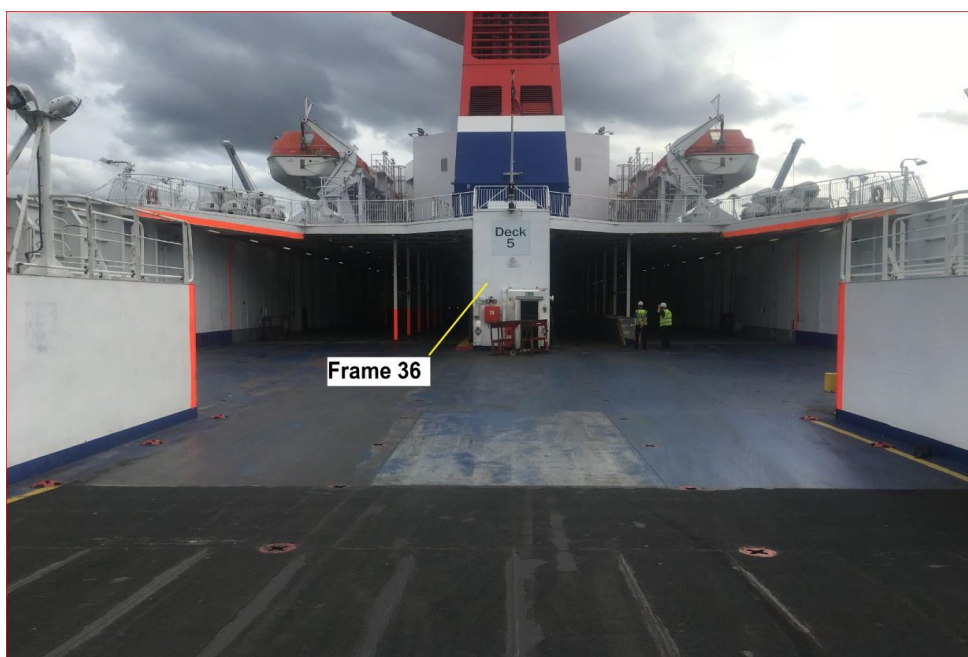

Figure 46: Above figure showing *Ferry RoPax* from aft. Roller shutter will be fitted at frame 36

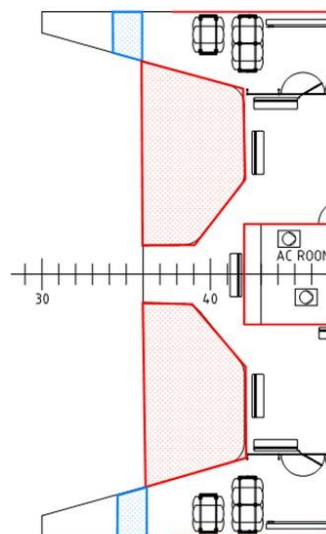

Figure 47: View from above. Roller shutter will be fitted at frame 36. Red is plate insert and blue is plate

A concern from a safety point of view is the hindered passage between the closed ro-ro space and the sealed weather deck part. It has been noted that all offered solutions for closing devices, except one¹⁰, come without door for access, the implication being that when the device is closed the weather deck will be inaccessible for fire patrolling, first response, and fire fighters unless the shutter is opened.

The closing device will be operated 12 times a day each. It could not be evaluated at this stage if the door will wear unexpectedly by this or if it will need much maintenance. The effect of sea side outdoor environment has also not been considered.

Scuppers are needed in vicinity to the closing device.

For the *Ferry RoPax*, the included items are: added exhaust ventilation capacity, 2 roller shutters b x h 11.1 x 5.15 m including steelwork and installation, added steel deck, scupper, minor adjustment of detection and drencher, as well as a yearly cost for the loss of cargo capacity and for operating fans.

¹⁰ The hinged starboard side steel door on the *Standard RoPax*. This one could easily accommodate a door, but it appeared not necessary since there is already a corridor in the funnel connecting weather deck with the now closed deck on starboard side.

Table 40: Details of the costs for the implementation of the RCO *Ban/Closure of side & end openings* on Existing ships

Ban/closure of side & end openings	Cargo RoPax	Standard RoPax	Ferry RoPax	Reference
Yearly losses total	€ 10 000	€ 120 000	€ 1 780 000	
Investment total	€ 515 000	€ 1 187 000	€ 905 000	
Added ventilation capacity	€ 100 000	€ 500 000	€ 250 000	Conversion expertise / fleet manager
<i>Steel and work, closing sides</i>	<i>€ 10 000</i>	<i>€ 150 000</i>	<i>€ 0</i>	<i>Conversion expertise / fleet manager</i>
Aft closing and installation	€ 395 000	€ 527 000	€ 635 000	Maker / conversion expertise
Scupper	€ 10 000	€ 10 000	€ 10 000	Conversion expertise
<i>Adjustment to existing systems, such as detection, suppression</i>			<i>€ 10 000</i>	<i>Conversion expertise</i>

All the above costs presented in Table 40 are marginal costs. Table 41 summarises the lifetime marginal costs (in present value) for the implementation of the RCO *Closing side and aft openings* on Existing ships.

Table 41: Lifetime marginal cost (in present value) for the implementation of the RCO *Ban/Closure of side & end openings* on Existing ships

Ban/closure of side & end openings	Cargo RoPax	Standard RoPax	Ferry RoPax
Delta Cost	€ 657 000	€ 2 892 000	€ 26 203 000

12.2.1.2 Newbuildings

For Newbuildings, the “steelwork and closing sides” can be approximated to zero (even though there will be a cost for more material compared to the open design). Also “adjustments in existing systems” would be zero.

Table 42: Details of the costs for the implementation of the RCO *Ban/Closure of side & end openings* on Newbuildings

Ban/closure of side & end openings	<i>Cargo RoPax</i>	<i>Standard RoPax</i>	<i>Ferry RoPax</i>	Reference
Yearly losses total	€ 10 000	€ 120 000	€ 25 000	
Investment total	€ 480 000	€ 1 002 000	€ 804 000	
Added ventilation capacity	€ 100 000	€ 500 000	€ 250 000	Conversion expertise / fleet manager
Aft closing and installation	€ 370 000	€ 492 000	€ 544 000	Maker / conversion expertise
Scupper	€ 10 000	€ 10 000	€ 10 000	Conversion expertise

Yearly losses for the newbuilding are difficult to estimate and very dependent on vessel. It is believed that the *Ferry RoPax* in this study with minor changes would not suffer loss of cargo and hence only €25 000 is left in yearly cost for running fans. By redesigning for more weather decks this might be reduced slightly. The *Cargo RoPax* costs remain the same. For the *Standard RoPax* the loss of cargo is mainly due to the closing of the side openings and hence only a major change on ship design could accommodate for this loss. That cost has not been evaluated and hence the figure for yearly losses is kept.

Table 41 summarises the lifetime marginal costs (in present value) for the implementation of the RCO *Closing side and aft openings* on Newbuildings.

Table 43: Lifetime marginal cost (in present value) for the implementation of the RCO *Ban/Closure of side & end openings* on Newbuildings

Ban/closure of side & end openings	<i>Cargo RoPax</i>	<i>Standard RoPax</i>	<i>Ferry RoPax</i>
Delta Cost	€ 694 000	€ 3 574 000	€ 1 340 000

12.2.2 *RCO Containment – Fire monitors on weather deck*

The costs were estimated based on manufacturer's recommendation on number of monitors and their equipment offers. Conversion costs are yard-dependent and may therefore vary. Costs provided in this study are based on a European yard.

A technical description of the selected system has been provided in paragraph 10.4.2.

12.2.2.1 *Existing ships*

All systems were chosen so that existing drencher pumps and sea chests can be used for water supply. Therefore, the cost estimation includes piping, valves, installation, remote controlled system, commissioning, and scupper.

For the *Cargo RoPax*, 3 fire monitors are necessary to cover the weather deck area, and approximately 130 m piping. The fire monitors localisation and coverages are shown in Figure 48.

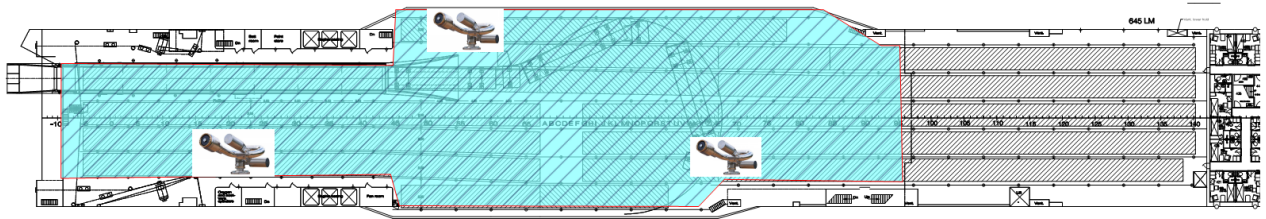

Figure 48: Cargo RoPax – Fire monitors localisation and coverages

For the *Standard RoPax*, 4 fire monitors covering both upper car deck and the weather deck part of Deck 4 are considered, requiring 140 m piping. It shall be noted that Area 2 which starts at frame 15 is considered weather deck but is covered by deck above. It cannot be reached by monitors but is instead protected by drencher as fixed suppression system. Area 1 will be reached by monitors from deck above. This arrangement is illustrated in Figure 49.

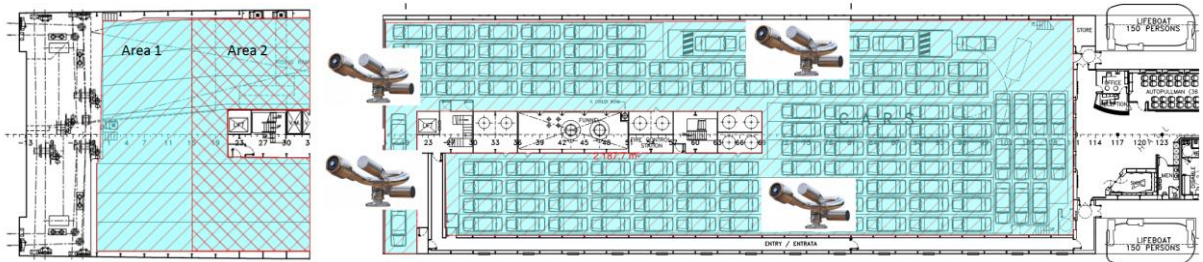

Figure 49: Standard RoPax – Fire monitors localisation and coverages

For the *Ferry RoPax*, 2 fire monitors are necessary to cover the weather deck (Deck 5 aft part), with approximately 100 m piping. This fire monitors localisation and coverages are provided for in Figure 50.

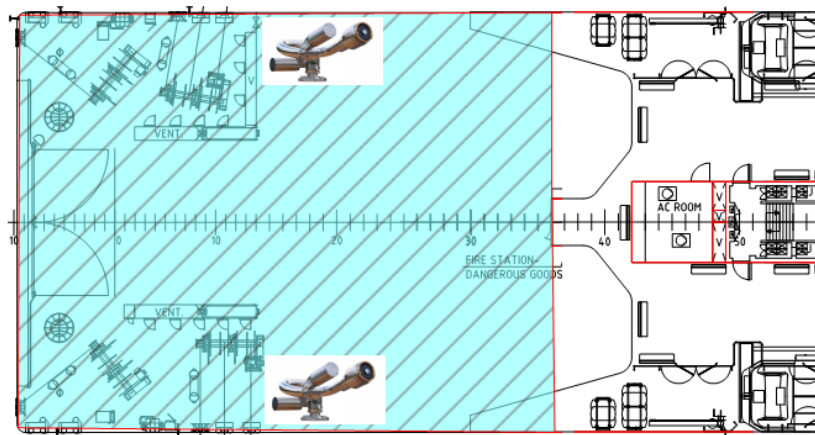

Figure 50: Ferry RoPax – Fire monitors localisation and coverages

Details of the costs for the implementation of the RCO *Fire monitors on weather deck* on Existing ships are summarized in Table 44.

Table 44: Details of the costs for the implementation of the RCO *Fire monitors on weather deck* on Existing ships

Fire monitors on weather deck	<i>Cargo RoPax</i>	<i>Standard RoPax</i>	<i>Ferry RoPax</i>	Reference
Investment total	€ 129 000	€ 145 500	€ 100 500	
Fire monitors	€ 33 000	€ 44 000	€ 22 000	Maker
Remote control	€ 8 500	€ 8 500	€ 8 500	Maker
Piping, valves, installation	€ 75 500	€ 81 000	€ 58 000	Conversion expertise
Scuppers	€ 10 000	€ 10 000	€ 10 000	Conversion expertise
Commissioning	€ 2 000	€ 2 000	€ 2 000	Maker

Maintenance of these system are included in the usual maintenance scheme and therefore do not increase the cost. All of the costs presented in Table 44 are investment and marginal costs. Table 45 summarises the lifetime marginal costs (in present value) for the implementation of the RCO *Fire monitors on weather deck* on Existing ships.

Table 45: Lifetime marginal cost (in present value) for the implementation of the RCO *Fire monitor on weather deck* on Existing ships

Fire monitors on weather deck	<i>Cargo RoPax</i>	<i>Standard RoPax</i>	<i>Ferry RoPax</i>
Delta Cost	€ 129 000	€ 145 500	€ 100 500

12.2.2.2 *Newbuildings*

For Newbuildings, the costs are almost the same as for Existing ships since all of this is in excess of what would normally be built. However, a slight difference in installation cost is expected (man hour). System, piping and relevant valves and commissioning are expected to be the same.

It is estimated that the cost can be reduced by 23% for a newbuilding vessel of similar types as below. The lifetime marginal costs are summarized in Table 46.

Table 46: Lifetime marginal cost (in present value) for the implementation of the RCO *Fire monitor on weather deck* on newbuildings

Fire monitors on weather deck	<i>Cargo RoPax</i>	<i>Standard RoPax</i>	<i>Ferry RoPax</i>
Delta Cost	€ 99 000	€ 112 000	€ 77 000

12.2.3 RCO Evacuation – Safe distance

Background information and cost estimations for Ban or permanent closure of (sides or sides and aft) openings were provided in section 12.2. In this section, those estimations are summarized and presented in relation to the three measures that were selected with a view to achieve a safe distance to LSAs and embarkation stations.

12.2.3.1 Existing ships

Details of the costs for the three measures on Existing ships are summarized in Table 47 to Table 49.

12.2.3.1.1 Closing all significant openings

Table 47: Details of the costs for the implementation of the measure - Closing all significant openings on Existing ships

Evac 1: Closing all significant openings	Cargo RoPax	Standard RoPax	Ferry RoPax	Reference
Yearly losses total	€ 10 000	€ 120 000	€ 1 780 000	
Investment total	€ 515 000	€ 1 187 000	€ 905 000	
Added ventilation capacity	€ 100 000	€ 500 000	€ 250 000	Conversion expertise / fleet manager
Steel and work, closing sides	€ 10 000	€ 150 000	€ 0	Conversion expertise / fleet manager
Aft closing and installation	€ 395 000	€ 527 000	€ 635 000	Maker / conversion expertise
Scupper	€ 10 000	€ 10 000	€ 10 000	Conversion expertise
Adjustment to existing systems, such as detection, suppression			€ 10 000	Conversion expertise

12.2.3.1.2 Closing all side openings

Table 48: Details of the costs for the implementation of the measure - Closing all side openings on Existing ships

Evac 2: Closing all side openings	Standard RoPax	Reference
Yearly losses total	€ 120 000	
Investment total	€ 660 000	
Added ventilation capacity	€ 500 000	Conversion expertise / fleet manager
Steel and work, closing sides	€ 150 000	Conversion expertise / fleet manager
Gutter	10 000€	Conversion expertise

12.2.3.1.3 Closing side openings near LSAs

Table 49: Details of the costs for the implementation of the measure - Closing side openings near LSAs on Existing ships

Closing side openings near LSAs	Standard RoPax	Reference
Investment total	€ 30 000	
Steel and work, closing sides	€ 30 000	Conversion expertise / fleet manager

It was assumed that the closure of openings does not interfere with the open deck definition (see 12.2.3.1.3). This can also be handled through opening another hole further away from LSAs for compensation.

12.2.3.1.4 Lifetime marginal cost: summary

Table 50 summarises the lifetime marginal cost (in present value) for the three measures investigated within the RCO *Safe distance* on existing ships.

Table 50: Lifetime marginal cost (in present value) for the implementation of the three measures investigated within the RCO *Safe distance* on existing ships

Designs / Existing ships	Cargo RoPax	Standard RoPax	Ferry RoPax
Closing all significant openings	657 000 €	2 892 000 €	26 203 000 €
Closing all side openings	N/A	2 365 000 €	N/A
Closing side openings near LSAs	N/A	30 000€	N/A

12.2.3.2 Newbuildings

Details of the costs for the three measures on Newbuildings are summarized in Table 51 to Table 53.

12.2.3.2.1 Closing all significant openings

Table 51: Details of the costs for the implementation of the measure - Closing all significant openings on newbuildings

Evac 1: Closing all significant openings	Cargo RoPax	Standard RoPax	Ferry RoPax	Reference
Yearly losses total	€ 10 000	€ 120 000	€ 25 000	
Investment total	€ 480 000	€ 1 002 000	€ 804 000	
Added ventilation capacity	€ 100 000	€ 500 000	€ 250 000	Conversion expertise / fleet manager
Aft closing and installation	€ 370 000	€ 492 000	€ 544 000	Maker / conversion expertise
Scupper	€ 10 000	€ 10 000	€ 10 000	Conversion expertise

12.2.3.2.2 Closing all side openings

Table 52: Details of the costs for the implementation of the measure - Closing all side openings on newbuildings

Evac 2: Closing all side openings	Standard RoPax	Reference
Yearly losses total	€ 120 000	
Investment total	€ 500 000	
Added ventilation capacity	€ 500 000	Conversion expertise / fleet manager

12.2.3.2.3 Closing side openings near LSAs

Table 53: Details of the costs for the implementation of the measure - Closing side openings near LSAs on newbuildings

Closing side openings near LSAs	Standard RoPax	Reference
Investment / Yearly losses total	€ 0	

12.2.3.2.4 Lifetime marginal cost: summary

Table 50 summarises the lifetime marginal cost (in present value) for the three measures investigated within the RCO *Safe distance* on Newbuildings.

Table 54: Lifetime marginal cost (in present value) for the implementation of the three measures investigated within the RCO *Safe distance* on existing ships

Designs / Newbuildings	Cargo RoPax	Standard RoPax	Ferry RoPax
Closing all significant openings	694 000 €	3 574 000 €	1 340 000 €
Closing all side openings	N/A	3 072 000 €	N/A
Closing side openings near LSAs	N/A	0 €	N/A

12.3 GCAF / NCAF ratio and RCOs ranking

Table 55 to Table 60 summarize the inputs value for the calculation of the GCAF and NCAF (as defined in (IMO, 2018)).

The Δ Risk is difference of the potential loss of life over the expected lifetime of the vessel after and before the implementation of the RCO. The Δ Cost, in present value, is the difference of the lifetime costs between reference system and the system with RCO. The Δ Benefits, in present value, is the lifetime economic benefits (reduced loss of cargo and reduced loss of ship) that follow the implementation of an RCO.

These tables also present the result of the cost benefit analysis and assessment by providing the GCAF.

The GCAF Factor is the ratio between the GCAF as calculated and the CAF criterion of €7.00M that was selected in the first part of FIRESAFE II (EMSA, 2018) and indicates a cost efficiency with values less or equal to 1.00.

Note that the effect of cumulative RCOs has not been assessed quantitatively and should not be performed by addition of contribution of individual RCO.

12.3.1 Containment – Newbuildings

Table 55 lists the input values Δ Risk and Δ Cost, as well as the resulting cost effectiveness ratios GCAF, and GCAF Factors for the considered Containment RCOs on Newbuildings.

Table 55: Δ Risk, Δ Costs, GCAF and GCAF Factor values for the Containment RCOs on Newbuildings

Newbuildings	Risk Control Options	Δ Risk	Δ Cost	GCAF			Rank
		Averted fat.	Present Value	GCAF	GCAF Factor	Cost effective	
Cargo RoPax	Ban/closure of side & end openings (closed and open ro-ro spaces)	4.09E-02	694 310 €	16 995 653 €	2.43	No	2
	Fire monitors on weather deck	1.09E-01	99 330 €	912 074 €	0.13	Yes	1
Standard RoPax	Ban/closure of side & end openings (closed and open ro-ro spaces)	1.55E-01	3 573 722 €	23 121 545 €	3.30	No	2
	Fire monitors on weather deck	2.33E-01	112 035 €	480 591 €	0.07	Yes	1
Ferry RoPax	Ban/closure of side & end openings (closed and open ro-ro spaces)	9.61E-02	1 339 775 €	13 946 185 €	1.99	No	2
	Fire monitors on weather deck	2.60E-01	77 385 €	297 769 €	0.04	Yes	1

For the three ships considered, the most cost-effective RCO is the *Fire monitors on weather deck*. In absolute terms, this RCO was found cost-effective with a GCAF factor of 0.13, 0.07 and 0.04 for the *Cargo RoPax*, *Standard RoPax* and the *Ferry RoPax* respectively.

The RCO *Ban/closure of side & end openings (closed and open ro-ro spaces)* has the highest costs (due to loss of cargo capacity) and the lowest risk reduction. Regardless of the ship category, this RCO do not meet the cost-effectiveness criteria.

The Table 56 lists the input values Δ Risk, Δ Cost, Δ Benefits and as well as the resulting cost effectiveness ratios NCAF, and NCAF Factors for the considered Containment RCOs on Newbuildings. The NCAF was found negative for the RCO *Fire monitors on weather decks* for the three ship categories.

Table 56: Δ Risk, Δ Costs, Δ Benefits, NCAF and NCAF Factor values for the Containment RCOs on Newbuildings

Newbuildings	Risk Control Options	Δ Risk	Δ Cost	Δ Benefits	NCAF			
		Averted fat.	Present Value	Present Value	NCAF	NCAF Factor	Cost effective	Rank
Cargo RoPax	Ban/closure of side & end openings (closed and open ro-ro spaces)	4.09E-02	694 310 €	139 774 €	13 574 204 €	1.94	No	2
	Fire monitors on weather deck	1.09E-01	99 330 €	314 222 €	-1 973 197 €	-0.28	Yes	1
Standard RoPax	Ban/closure of side & end openings (closed and open ro-ro spaces)	1.55E-01	3 573 722 €	83 070 €	22 584 095 €	3.23	No	2
	Fire monitors on weather deck	2.33E-01	112 035 €	144 470 €	-139 137 €	-0.02	Yes	1
Ferry RoPax	Ban/closure of side & end openings (closed and open ro-ro spaces)	9.61E-02	1 339 775 €	52 855 €	13 396 003 €	1.91	No	2
	Fire monitors on weather deck	2.60E-01	77 385 €	88 596 €	-43 137 €	-0.01	Yes	1

12.3.2 Containment – Existing ships

Table 57 lists the input values Δ Risk and Δ Cost, as well as the resulting cost effectiveness ratios GCAF, and GCAF Factors for the considered Containment RCOs on Existing ships.

All of the observations presented for the Newbuildings remains applicable for the Existing ships.

Table 57: Δ Risk, Δ Costs, GCAF and GCAF Factor values for the Containment RCOs on Existing ships

Existing ships	Risk Control Options	Δ Risk	Δ Cost	GCAF			
		Averted fat.	Present Value	GCAF	GCAF Factor	Cost effective	Rank
Cargo RoPax	Ban/closure of side & end openings (closed and open ro-ro spaces)	2.06E-02	657 124 €	31 921 596 €	4.56	No	2
	Fire monitors on weather deck	5.46E-02	129 000 €	2 361 216 €	0.34	Yes	1
Standard RoPax	Ban/closure of side & end openings (closed and open ro-ro spaces)	7.79E-02	2 892 488 €	37 144 737 €	5.31	No	2
	Fire monitors on weather deck	1.18E-01	145 500 €	1 238 170 €	0.18	Yes	1
Ferry RoPax	Ban/closure of side & end openings (closed and open ro-ro spaces)	4.88E-02	26 203 078 €	537 390 177 €	76.77	No	2
	Fire monitors on weather deck	1.31E-01	100 500 €	769 066 €	0.11	Yes	1

Table 58 presents the results of the cost-effectiveness assessment, taking into account the economic benefits of the risk control options. The RCOs *Fire monitors on weather deck* achieves a negative NCAF for all generic ships. However, the RCO *Ban / Closure of side & end openings* was still found not cost-effective for the three ship categories.

Table 58: Δ Risk, Δ Costs, Δ Benefits, NCAF and NCAF Factor values for the Containment RCOs on Existing ships

Existing ships	Risk Control Options	Δ Risk	Δ Cost	Δ Benefits	NCAF			
		Averted fat.	Present Value	Present Value	NCAF	NCAF Factor	Cost effective	Rank
Cargo RoPax	Ban/closure of side & end openings (closed and open ro-ro spaces)	2.06E-02	657 124 €	93 810 €	27 364 499 €	3.91	No	2
	Fire monitors on weather deck	5.46E-02	129 000 €	209 523 €	-1 473 887 €	-0.21	Yes	1
Standard RoPax	Ban/closure of side & end openings (closed and open ro-ro spaces)	7.79E-02	2 892 488 €	55 490 €	36 432 145 €	5.20	No	2
	Fire monitors on weather deck	1.18E-01	145 500 €	96 527 €	416 746 €	0.06	Yes	1
Ferry RoPax	Ban/closure of side & end openings (closed and open ro-ro spaces)	4.88E-02	26 203 078 €	35 757 €	536 656 844 €	76.67	No	2
	Fire monitors on weather deck	1.31E-01	100 500 €	59 367 €	314 766 €	0.04	Yes	1

12.3.3 Evacuation – Newbuildings

It should be noted that the Evacuation RCOs have no effect on the Potential Loss of Ship and Potential Loss of Cargo. The ship and cargo it transports are considered as total losses for such scenarios, regardless of the evacuation success or failure Table 59 lists the input values Δ Risk and Δ Cost, as well as the resulting cost effectiveness ratios GCAF, and GCAF Factors for the different designs investigated for the Evacuation RCO on Newbuildings.

Table 59: Δ Risk, Δ Costs, GCAF and GCAF Factor values for the different designs investigated for the Evacuation RCO on Newbuildings

Newbuildings	Design investigated	Δ Risk	Δ Cost	GCAF			
		Averted fat.	Present Value	GCAF	GCAF Factor	Cost effective	Rank
Cargo RoPax	Closing all significant openings	2.81E-03	694 310 €	247 364 000 €	35.34	No	1
Standard RoPax	Closing all significant openings	1.97E-01	3 573 722 €	18 129 785 €	2.59	No	2
	Closing all side openings	1.22E-01	3 071 722 €	25 229 778 €	3.60	No	3
	Closing side openings near LSAs	1.97E-01	- €	- €	0.00	Yes	1
Ferry RoPax	Closing all significant openings	4.19E-01	1 339 775 €	3 195 309 €	0.46	Yes	1

12.3.4 Evacuation – Existing ships

Table 60 lists the input values Δ Risk and Δ Cost, as well as the resulting cost effectiveness ratios GCAF, and GCAF Factors for the considered Evacuation RCOs on Existing ships.

Table 60: Δ Risk, Δ Costs, GCAF and GCAF Factor values for the different designs investigated for the Evacuation RCO on Existing ships

Existing ships	Design investigated	Δ Risk	Δ Cost	GCAF			
		Averted fat.	Present Value	GCAF	GCAF Factor	Cost effective	Rank
Cargo RoPax	Closing all significant openings	1.43E-03	657 124 €	460 587 757 €	65.80	No	1
Standard RoPax	Closing all significant openings	1.00E-01	2 892 488 €	28 887 323 €	4.13	No	2
	Closing all side openings	6.18E-02	2 365 488 €	38 248 651 €	5.46	No	3
	Closing side openings near LSAs	1.00E-01	30 000 €	299 610 €	0.04	Yes	1
Ferry RoPax	Closing all significant openings	2.13E-01	26 203 078 €	123 069 948 €	17.58	No	1

12.4 Results of the sensitivity and uncertainty analyses

A number of uncertainties were introduced while developing the risk model. As listed in (IMO, 2007), various degrees of uncertainty were associated with the following areas and factors:

- Scope and limitations: three generic ships were selected to represent the RoPax world fleet;
- Statistics: historical data are scarce and may be uncomplete;
- Outlined models: omitted branches, and not time-dependent event tree;
- The expert judgments: other set of experts may have provided slightly different estimates;
- The assumptions: Yes/no probabilities; and
- Assumptions on the number of fatalities per final outcome of each event branch.

Some of the assumptions made in the risk assessment part were conservative, leading to a potential over estimation of the societal risk. As far as practicable, a high level of attention was given to explicit all assumptions used in the study with the aim to ease any potential modifications or updates of the assumptions with new data sets or different expert judgements.

Sensitivity and uncertainty analyses were performed as part of the study, where the quantifications of the risk model and in the effectiveness quantifications of RCOs were evaluated. No uncertainty was considered for the cost estimations.

Uncertainty of the estimated parameters was explicitly modelled with probability distributions for each bottom nodes of the sub risk models. Additional details on the methodology followed were provided in Annex A2 of the report for Part 1 of the FIRESAFE II study (EMSA, 2018). The risk assessment software @Risk (Palisade Decision Tool ©), an add-in to Microsoft Excel, was then used to perform Monte Carlo simulations (sampling of the parameters from their probability distribution) to estimate confidence intervals for the PLL and GCAF Factors.

As for the sensitivity analysis, with regard to containment failure, the biggest impact was seen from failure of boundary cooling, principally when there is an unsuppressed fire. For scenarios involving suppressed fires, damages on doors was deemed to be the largest contributor together with failure of navigation in a way to avoid smoke. The former pertains to closed ro-ro spaces, whereas the latter concerns open ro-ro spaces.

Regarding evacuation, as conservative assumptions were taken with regard to the impact of smoke on evacuation, the parameter *Unfavourable wind* was given a high uncertainty to assess its impact on the overall evacuation failure probability.

The results of the uncertainty analysis of the containment and evacuation RCOs are summarized in Table 61 and elaborated subsequently.

Table 61: Confidence (conf) of Containment and Evacuation RCOs having GCAF<1 based on uncertainty analysis

	Cargo				Standard				Ferry			
	New		Exist.		New		Exist.		New		Exist.	
	GCAF stat	GCAF conf	GCAF stat	GCAF conf	GCAF stat	GCAF conf	GCAF stat	GCAF conf	GCAF stat	GCAF conf	GCAF stat	GCAF conf
Containment												
Ban/closure of side & end openings (closed and open ro-ro spaces)	2.42	1%	4.54	0%	3.30	0%	5.31	0%	1.97	7%	76.4	0%
Fire monitors on weather deck	0.13	100%	0.34	100%	0.07	100%	0.18	100%	0.04	100%	0.11	100%
Evacuation												
Closing all significant openings	35.2	0%	64.5	0%	2.59	0%	4.13	0%	0.46	98%	17.5	0%
Closing all side openings					3.60	0%	5.46	0%				
Closing side openings near LSAs					0.00	100%	0.04	100%				

The uncertainty analysis of the Containment and Evacuation RCOs showed that most of the results from the static values are reliable. Most of the RCOs achieved static GCAF factor well below or well above 1. For the design *Closing all significant openings* on *Ferry RoPax* Newbuildings, the static GCAF factor was 0.46 and therefore considered cost-efficient. The uncertainty analysis mainly strengthened this results by showing a very high confidence (98%) for cost-efficiency.

12.5 Objective comparison of alternative options

12.5.1 Containment

Table 62 and Table 63 summarise the GCAF ratios and the relative risk reduction of the Containment RCOs. Cost-effective RCOs are identified by the green cells.

Table 62: GCAF Factors for the different containment RCOs on each generic vessel (for both Newbuildings and Existing ships)

Containment		Newbuildings			Existing ships		
RCO #	Description	Cargo RoPax	Standard RoPax	Ferry RoPax	Cargo RoPax	Standard RoPax	Ferry RoPax
Cont1	Ban/closure of side & end openings (closed and open ro-ro spaces)	2.43	3.30	1.99	4.56	5.31	76.77
Cont2	Fire monitors on weather deck	0.13	0.07	0.04	0.34	0.18	0.11

Table 63: Relative risk reduction for the different containment RCOs on each generic vessel (for both Newbuildings and Existing ships)

Containment		Newbuildings			Existing ships		
RCO #	Description	Cargo RoPax	Standard RoPax	Ferry RoPax	Cargo RoPax	Standard RoPax	Ferry RoPax
Cont1	Ban/closure of side & end openings (closed and open ro-ro spaces)	15.33%	16.67%	6.81%	15.38%	16.62%	6.83%
Cont2	Fire monitors on weather deck	40.88%	25.14%	18.43%	40.82%	25.08%	18.30%

The following RCOs are providing considerable risk reduction in a cost-effective manner (from low GCAF to high GCAF):

- For Newbuildings:
 - Regardless of the ship category:
 - RCO Cont2: Fire monitors on weather deck.
- For Existing ships:
 - Regardless of the ship category:
 - RCO Cont2: Fire monitors on weather deck.

12.5.2 Evacuation

Table 64 and Table 65 summarise the GCAF ratios and the relative risk reduction of the RCOs. Cost-effective RCOs are identified by the green cells. For *Standard RoPax*, the GCAF ratio and relative risk reduction of the most cost-effective design are reported in the Table 64 and Table 65.

Table 64: GCAF Factor for the evacuation RCO on each generic vessel (for both Newbuildings and Existing ships)

Evacuation		Newbuildings			Existing ships		
RCO #	Description	Cargo RoPax	Standard RoPax	Ferry RoPax	Cargo RoPax	Standard RoPax	Ferry RoPax
Evac1	Safe distance	N/A	0.00	0.46	N/A	0.04	17.58

Table 65: Relative risk reduction for the Evacuation RCO on each generic vessel (for both Newbuildings and Existing ships)

Evacuation		Newbuildings			Existing ships		
RCO #	Description	Cargo RoPax	Standard RoPax	Ferry RoPax	Cargo RoPax	Standard RoPax	Ferry RoPax
Evac1	Safe distance	N/A	13%	30%	N/A	13%	30%

The RCO *Safe distance* is providing considerable risk reduction in a cost-effective manner for all the ship categories for both Newbuildings and for the *Standard RoPax* Existing ships.

For *Standard RoPax*, the previous analysis shown that there was at least one measure to achieve the safe distance in a cost-effective manner.

13 RECOMMENDATION FOR DECISION-MAKING

13.1 Recommendation for decision-making

A Risk Control Option was considered cost-effective if the Gross Cost of Averting a Fatality (GCAF) is below €7 M. A Risk Control Option was also considered cost-effective if the Net Cost of Averting a Fatality (NCAF), accounting for the economic benefits of the RCO, is below €7 M.

No criteria for assessing the acceptability of the risks associated with a particular hazard (here fires in ro-ro spaces) are available to support decision-making at IMO. However, several cost-effective risk control options were identified and could be recommended to improve the safety level of the RoPax world fleet (listed below in order of risk reduction potential)¹¹:

- For Newbuildings:
 - Regardless of the ship category:
 - Fire monitors on weather deck; and
 - Safe distance.
- For Existing ships:
 - Regardless of the ship category:
 - Fire monitors on weather deck.
 - For Standard RoPax:
 - Safe distance.

The following RCOs were not found to be cost-effective and are therefore not recommended as mandatory requirements:

- For Newbuildings:
 - Regardless of the ship category:
 - Ban of side & end openings (closed and open ro-ro spaces).
- For Existing ships:
 - Regardless of the ship category:
 - Closure of side & end openings (closed and open ro-ro spaces).
 - For the Ferry RoPax:
 - Safe distance.

Some RCOs are already (voluntarily or mandatory) implemented by some ship owners, operating their ships above minimum SOLAS requirements. Such actions are encouraged, regardless of the cost-effectiveness reported above. The results of the cost-effectiveness assessment reported in FIRESAFE II are believed to be representative for the world fleet, but they may be impacted by the intrinsic safety culture and specific procedures of the specific ship operators.

The focus of the Evacuation part of the study was on protection of stowage areas, embarkation stations and LSA failure due to heat, conservative assumptions were taken with regard to the impact of smoke on evacuation. Therefore, it is recommended to further investigate this specific topic to refine and improve the robustness of the model.

Although the safety distances stated above are general, it should be noted that they were based on investigations of specific design solutions on different ships. Furthermore, the 8 m and 13 m criteria were proposed as additional outputs of the study, based on certain assumptions. Before implementation into regulations, the proposed safety distances would benefit from being discussed with regard to the assumed critical conditions for LSAs and humans (see e.g. Figure 16) as well as the critical assumptions made for the heat exposure simulations and calculations (e.g. size of fire, size of openings and model assumptions).

¹¹ As a general guidance, when several RCOs are cost-effective, the risk control options selection process should focus on preventive rather than mitigating measures, design rather than procedural measures, and should consider the risk reduction potential and the GCAF ranking, along with the uncertainty.

It should be noted that the risk reduction provided by each RCO was estimated with the assumption that none of the other RCOs were implemented (i.e. each RCO was assessed independently).

It should be also noted that the relative risk reductions presented and discussed above only take into account the effects of the RCOs on the respective Containment and Evacuation nodes in the main fire risk model. However, any effects that the RCOs could have directly on the other main branches of the main fire risk model event tree were disregarded, which may influence the cost-effectiveness of the RCOs.

These considerations were taken into account in the Combined Assessment part of the FIRESAFE II study (EMSA, 2018).

13.2 Discussion on how recommendations could be implemented by decision-makers

13.2.1 Background

In view of the above results, amendments to IMO regulations are discussed for the implementation of the Risk Control Options that proved to be cost-effective.

13.2.1.1 Graphic codes

Amendment proposals are presented with the convention used in IMO documents i.e.:

- Deletions are stroke through: ~~Example~~
- Additions are shown with a grey background: **Example**

13.2.1.2 Retroactivity

The amendment proposals detailed in the section below would, as amendments of SOLAS or FSS Code, be applicable only to ships built after their date of entry into force. In case it is decided to make these requirements also applicable to existing ships, the following requirement should be added in SOLAS II-2/1.2

2.9 Ships constructed before XXX* shall comply with regulations 20.4.1, 20.2.2.4, 20.3.1.5.2, 20.4.3.1, 20.4.4, 20.6.1.5, 20.6.1.6 and 20.6.2 not later than the first renewal survey on or after YYY*

*XXX Date of entry into force of the amendments for newbuildings

YYY Date by which existing ships would have to comply with the new requirements. Delay may be needed, especially if it is considered to close any opening on the side.

13.2.2 Fire monitors on weather deck

This RCO was extensively discussed in the section 10.4.2. The purpose of this RCO is to require water monitors on weather decks intended for the carriage of vehicles in order to extinguish or contain a fire starting on this weather deck and in order to cool down adjacent boundaries to limit structural damage.

The following features are outlined:

- The fire monitors on weather deck and drencher / fixed water-based fire extinguishing system for open or closed ro-ro spaces may be fed by the same pump and piping system; and
- Remote control from a safe position

13.2.2.1 Amendment proposal

It is proposed to add the following requirement in SOLAS II-2/20.6, after the existing regulation II-2/20.6.1, and to renumber the following regulations accordingly:

6.2 Water monitors on weather decks

6.2.1 On passenger ships, water monitors shall be provided on the weather decks intended for the carriage of vehicles. The arrangement, length and height of throw of the water monitors shall be sufficient to reach 90% of:

.1 The area intended for the storage of vehicles on the weather deck; and

.2 The area, including superstructure boundaries, located within [8m] measured horizontally from the area intended for vehicle storage.

6.2.2 The combined capacity of all water monitors shall be such as to provide an average coverage of 2L/min per square meter of protected area.

6.2.3 It shall be possible to remotely operate the fire monitors from a safe position in case of a fire on the weather deck.

6.2.4 Where the ship's required fire pumps are used to feed the water monitors:

.1 It shall be possible to segregate the ship's fire main from the water monitors by means of a valve in order to operate both systems separately or simultaneously

.2 The capacity of the pumps shall be sufficient to serve both systems simultaneously

6.2.5 Where the pump dedicated to the fixed pressure water spraying system required by regulation 20.6.1.2 is used to feed the water monitors, it shall be possible to segregate both systems by means of a valve and both systems need not be able to operate simultaneously.

6.2.6 Suitable scupper or freeing ports are to be provided to ensure efficient drainage of water accumulating on deck surfaces when the fire monitors are in operation. Discharge valves for scuppers shall be kept open while the ship is at sea.

Note 1: SOLAS II-2/10.7.3 requires mobile fire monitors (that can be plugged on fire hydrants) on container ships. However, the intent here is to require fixed water monitor, therefore the proposed wording is different.

Note 2: The proposed capacity requirement is in line with the total capacity considered in the second part of FIRESAFE II:

	Cargo RoPax	Standard RoPax	Ferry RoPax
B [m]	20.25	25.5	25
L [m]	171.05	186.5	203.3
L _{weather deck} [m] (rough estimate)	81	73	32
Nb of fire monitors (1000L/min each)	3	4	2
Capacity (rough estimate)	1000 x 3 / (81*20.25) = 1.8 L/min/m ²	1000 x 4 / (73*25.5) = 2.1 L/min/m ²	1000 x 2 / (32*25) = 2.5 L/min/m ²

It is to be noted that this 2L/min/m² is significantly below the capacity required for drencher systems (3.5L/min/m² or 5L/min/m²) which is justified by the fact that:

- A fire on a weather deck does not behave in the same way as a fire in an enclosed space; and
- The fire monitors will concentrate on a local fire area, not flood the whole weather deck at once.

Note 3: The 8m criterion here is proposed by coherence with the criterion proposed for LSAs, see 13.2.3. This value would benefit from being further discussed.

Note 4: Only 90% coverage is required, in line with the assumptions considered for the study. Indeed, shading due to e.g. exhaust chimneys can happen and covering the shaded areas would require additional monitors. This is not deemed necessary as global cooling is the main intent of this RCO.

13.2.2.2 Further development

It may be relevant to identify or develop an approval standard for fire monitors.

13.2.3 Distance between LSAs and openings

13.2.3.1 RCO presentation

This RCO was extensively discussed in the section 11. The purpose of this RCO is to prevent LSAs from being exposed to and possibly damaged by a fire in a vehicle space. One RCO ensuring safe evacuation on RoPax ships was identified and defined as a design with:

- A [13 m] safety distance between LSA embarkation stations and weather deck/ro-ro space aft openings;
- An [8 m] safety distance between stowed LSAs (including survival craft, not embarked onboard) and weather deck/ro-ro space aft openings; and
- No LSAs or embarkation station within the full vertical range 6 m forward and aft of a side opening larger than [0.01] m².

13.2.3.2 Amendment proposal

It is proposed to delete SOLAS regulation II-2/20.3.1.5 (which is only applicable to closed vehicle spaces, ro-ro spaces and special category spaces) and insert a new paragraph II-2/20.4 as follows – following paragraphs to be renumbered accordingly:

4 Permanent openings

4.1 Permanent openings in the side plating, the ends or deckhead of the space shall be so situated that a fire in the cargo space does not endanger stowage areas and embarkation stations for survival craft and accommodation spaces, service spaces and control stations in superstructures and deckhouses above the cargo spaces.

4.2 It is considered that stowage area and embarkation stations for survival craft are not endangered by a fire in the cargo space when:

.1 Survival craft is stowed:

.1.1 More than 6 m, measured horizontally, away from any opening to a vehicle or ro-ro space

.1.2 More than [8 m], measured horizontally, away from any weather deck area intended for the storage of vehicles

.2 Survival craft embarkation stations and muster stations are located:

.1.1 More than 6 m, measured horizontally, away from any opening to a vehicle or ro-ro space

.1.2 More than [13 m], measured horizontally, away from any weather deck area intended for the storage of vehicles

.3 Marine evacuation systems and lifeboats shall be in such position that they can be deployed or launched:

.1.1 More than 6 m, measured horizontally, away from any opening to a vehicle or ro-ro space

.1.2 More than [8 m], measured horizontally, away from any weather deck area intended for the storage of vehicles

Note 1: The 8 m and 13 m criterion were proposed as additional outputs of the study. The proposed safety distances would benefit from being further discussed.

13.2.4 *Ban of side & end openings*

This RCO was extensively discussed in the section 10.4.1. The purpose of this RCO is to ban or close open ro-ro spaces and reduce openings as much as possible on closed ro-ro spaces. This RCO was not found cost-effective in this study. However, it was recommended that further studies investigate this Risk Control Option with alternative hypothesis on the cost estimation. If this RCO were to be found cost-effective, the proposed amendment would be stated as follows.

13.2.4.1 *Amendment proposal*

It would be proposed to include the following requirement in SOLAS II-2/20.2:

2.2.4. Vehicles spaces and ro-ro spaces are to be either closed spaces or weather decks. Closed vehicles or ro-ro spaces shall be closed at both ends and the number of side openings shall be reduced to the minimum compatible with the design and proper working of the ship.
--

Note 1: Considering that this amendment is intended for passenger ships only, it is deemed relevant to keep the definitions for open ro-ro spaces and open vehicle spaces as are in SOLAS II-2/3.

Note 2: The wording “minimum compatible with the design and proper working of the ship” is copied from SOLAS II-1/15.1, because it is understood that some openings may still be needed for practical purposes.

13.2.4.2 *Further development*

In case it is decided to make this requirement retroactively applicable to existing ships, further interpretation may be needed to clarify how the separation between closed (previously open) ro-ro spaces and weather decks is to be achieved.

14 CONCLUSION

The main objective of FIRESAFE II was to improve the fire safety of ro-ro passenger ships by cost-efficient safety measures reducing the risk of ro-ro space fire, with an aim to discuss specific proposals for rule making. In Part 2 of the study, reported here, the objective was to identify a range of risk control options (RCOs) and assess the ones most likely to be cost efficient in relation to containment and evacuation due to a ro-ro space fire, considering open ro-ro spaces, closed ro-ro spaces as well as weather decks, for both Newbuildings and Existing ships.

The risk assessment and cost-effectiveness parts of this study were developed and quantified through investigation of available failure data, fire simulations, and in case none of the previous options were available, qualitative considerations and expert judgement. Therefore, although this study is believed to be based on the best available techniques and estimates, the results presented in this study should be considered carefully bearing in mind the inherent limitations of the modelling and data availability.

The results are considered to be meaningful and to represent the best estimates to date, considering the data available. Furthermore, as far as practicable, a high level of attention was given to explicit all assumptions used in the study with the aim to ease any potential modifications or updates of the assumptions with new data sets or different expert judgements.

Some of the assumptions made in the risk assessment part were conservative, leading to a potential over estimation of the societal risk. Although the consequence part of the main fire risk model was developed to be representative to the average consequences of accidents, it should be noted that a single accident leading to a high number of fatalities within a limited period in time may skew the estimated historical societal risk. This may create a difference between the estimated historical societal risk and the risk estimated with the risk model. An over-estimation of the societal risk will generally increase the risk reduction potential of RCOs.

The costs estimated in this study were based on the estimates provided by a single ship operator. Although all efforts were put to make this study applicable for the world fleet, the cost estimates are necessarily influenced by the geographical area considered and the inherent safety culture of the ship operator involved, which already implements some of the risk control options recommended in this study on a voluntarily basis.

Quantifying the effect of all of the above assumptions and their cross-effects with a high level of precision is not realistic and some of the various assumptions might skew the overall results. However, the sensitivity and uncertainty analysis performed in the context of this study allowed, to some extent, consideration to these effects and should be considered along with the best estimate for decision making. The results of this study were considered robust enough to lead to recommendations for decision making.

The results of this study can be summarized as follows:

To consider the diverse world fleet of RoPax ships in the study, three generic categories ships were defined based on a lane metre to passenger capacity ratio:

- *Ferry RoPax*, represent RoPax ships or ferries with focus on carriage of passengers but which can also carry cargo similar to a *Standard RoPax*. These ships typically only have closed ro-ro spaces or mainly closed ro-ro spaces and a small weather deck;
- *Standard RoPax*, represent the RoPax ships with focus on both carriage of cargo and of passengers. These vessels typically have each of the three types of ro-ro spaces: closed ro-ro spaces, open ro-ro spaces and weather decks. The size of the weather deck/s is generally medium to large within this category; and
- *Cargo RoPax*, represent RoPax ships with focus on carriage of cargo and basically have a passenger capacity just enough to carry the number of drivers necessary to load the ro-ro spaces with accompanied trailers. These vessels typically have closed ro-ro spaces and large weather deck/s.

Dedicated fault trees were developed focusing on the main hazards identified during the HazId. The trees were quantified to gain an understanding of the impacts on risks and to investigate in further detail the important causes and initiating events of the accident scenarios identified. This allowed quantification of the

contributing containment failures as well as to calculate the overall containment failure rate. Risk model were also developed with a focus on the protection of stowage areas, embarkation stations and LSA failure due to fire. In order to consider the different types of ro-ro spaces, different trees were developed and quantified by investigation of available failure data, fire simulations and expert judgement, in case none of the previous options were available.

The main fire risk model developed in FIRESAFE was updated in consideration of the new findings for the Containment and Evacuation nodes. The societal risk due to fires in ro-ro spaces was calculated for the three ship categories. For Newbuildings, the PLL were estimated as follows: *Cargo RoPax*: 6.66E-03 fatalities per shipyear, *Standard RoPax*: 2.32E-02 fatalities per shipyear, *Ferry RoPax* 3.53E-02 fatalities per shipyear. Only a slight difference of about 1% (increase in PLL) was observed for Existing ships, mainly due to the fact that the only difference considered in this study is the non-addressability of the detection on Existing ships.

A wide range of Containment Risk Control Measures (RCMs) were initially identified. Out of these, 7 of them were identified as most promising and as potentially practicable by the experts. These were thoroughly described and their benefits, critical aspects and interdependencies were discussed. Two of the above risk control options were selected for further quantitative cost-effectiveness analysis, based on their perceived cost-effectiveness, Technology Readiness Level (TRL), and availability:

- Ban/closure of side & end openings: From a containment point of view, the main benefit of fewer openings is to avoid smoke and flames escaping from the fire enclosure, preventing propagation of the fire to spaces above the opening and harmful exposure to smoke. Both open and closed ro-ro spaces have openings that could be closed. Ro-ro spaces are defined as closed also if there is an opening at one end and side openings are less than 10% of the total area of the space sides. (SOLAS II-2/3.12) This risk control measure implies to forbid open ro-ro spaces on new ships and to reduce openings (including aft openings) in general as far as practicable; and
- Fixed fire-extinguishing systems (e.g. fire monitors) on weather deck: Weather deck is fairly unprotected in case of fire, and cooling possibilities are limited with no means for local cooling. In a case of a fire on weather deck, the use of fire monitors might contain the propagation of the fire by reducing the amount of radiation from flames, and depending on the discharging rate, suppression or even extinguishment of the fire might be reached. For ro-ro passenger ships with a weather deck, fixed fire protection arrangements (here fire monitors) shall be provided for the purpose of containing a fire in the space or area of origin (i.e. the weather deck) and to cool adjacent areas to prevent fire spread and structural damage.

Regarding the failure of evacuation the main issue to be addressed is related to SOLAS Ch. II-2, Reg. 20.3.1.5: “*Permanent openings in the side plating, the ends or deckhead of the space shall be so situated that a fire in the cargo space does not endanger stowage areas and embarkation stations for survival craft and accommodation spaces, service spaces and control stations in superstructures and deckhouses above the cargo spaces.*” Based on simulations, the safe distance and arrangement of such openings were estimated. Several design solutions were investigated to achieve the RCO *Safe distance* on the *Standard RoPax* and *Ferry RoPax*, on which the LSAs were within the hazardous zone. Although the stowage areas, embarkation stations and LSAs were located outside of this zone on the *Cargo RoPax*, the closure of the aft opening was investigated to identify whether the safety level on this ship could be improved in a cost-effective manner.

Costs for the implementation of the considered RCOs were estimated. Technical items available on the market were as far as possible quantified by system supplier offers. In addition, cost estimations were based on existing costs for material from ship operator’s internal projects, specifications, reconstructions etc. The main component systems of each RCOs were identified and respective costs were estimated. Other cost items affecting for example operations were included in the quantification when necessary.

The cost-effectiveness criteria were updated. A Risk Control Option was considered cost-effective if the Gross Cost of Averting a Fatality (GCAF) is below €7 M. A Risk Control Option was also considered cost-effective if the Net Cost of Averting a Fatality (NCAF), accounting for the economic benefits of the RCO, is below €7 M.

The FSA demonstrated that the following RCOs achieved the highest risk reduction in a cost-effective manner:

-
- For Newbuildings:
 - Regardless of the ship category:
 - Fire monitors on weather deck; and
 - Safe distance.
 - For Existing ships:
 - Regardless of the ship category:
 - Fire monitors on weather deck.
 - For Standard RoPax
 - Safe distance

It should be noted that the relative risk reductions of the RCOs only take into account the effects of the RCOs on the respective Containment and Evacuation nodes in the main fire risk model. However, any effects that the RCOs could have directly on the other main branches of the main fire risk model event tree were disregarded which may render cost-effective some RCO that were not in this part. These considerations were taken into account in the Combined Assessment part of the FIRESAFE II study (EMSA, 2018).

15 BIBLIOGRAPHY

- Arvidson. (1997). *Large scale ro-ro vehicle deck fire test, NORDTEST Project 1299-96, BRANDFORSK Project 421-941*.
- Beyler, & Shokri. (1989). Radiation from larger pool fires. *SFPE Journal of Fire Protection Engineering*.
- EMSA. (2016). *Study investigating cost effective measures for reducing the risk from fires on ro-ro passenger ships (FIRESAFE)*. Lisbon: European Maritime Safety Agency.
- EMSA. (2018). *Second study investigating cost effective measures for reducing the risk from fires on ro-ro passenger ships (FIRESAFE II) - Combined Assessment*. Lisbon: European Maritime Safety Agency.
- EMSA. (2018). *Second study investigating cost effective measures for reducing the risk from fires on ro-ro passenger ships (FIRESAFE II) - Containment and Evacuation*. Lisbon: European Maritime Safety Agency.
- EMSA. (2018). *Second study investigating cost effective measures for reducing the risk from fires on ro-ro passenger ships (FIRESAFE II) - Detection and Decision*. Lisbon: European Maritime Safety Agency.
- Hanna, Briggs, & Hosker. (1982). *Handbook on atmospheric diffusion*.
- Heskestad. (1983). Luminous heights of turbulent diffusion flames. *Fire Safety Journal*.
- Heskestad. (1997). Flame heights of fuel arrays with combustion in depth. *Fire Safety Science*.
- HM Treasury. (2018). *The Green Book - Central Government Guidance on Appraisal and Evaluation*. London.
- IMO. (2001). *MSC/Circ.1006 - Guidelines on fire test procedures for acceptance of fire-retardant materials for the construction of lifeboats*. London: International Maritime Organization.
- IMO. (2007). *MSC 83/INF.8 - FSA - Container vessels - Details of the Formal Safety Assessment*. London: International Maritime Organization.
- IMO. (2012). *MSC.1/Circ.1430 - Revised Guidelines for the Design and Approval of Fixed Water-Based Fire-Fighting Systems for Ro-ro Spaces and Special Category Spaces*. London: International Maritime Organization.
- IMO. (2014). *International Convention for the Safety of Life at Sea (SOLAS)*. London: International Maritime Organization.
- IMO. (2016). *III 3/4/5 - Lessons learned and safety issues identified from the analysis of marine safety investigation reports – Use of accident data*. London: International Maritime Organization (Submitted by Cruise Lines International Association (CLIA) and International Association of Classification Societies (IACS)).
- IMO. (2018). *MSC-MEPC.2/Circ.12/Rev.2 - Revised Guidelines for Formal Safety Assessment (FSA) for Use in the IMO Rule-Making Process*. London: International Maritime Organization.
- IMO. (2018). *SSE 5/7/5 - Review Of SOLAS Chapter II-2 And Associated Codes To Minimize The Incidence And Consequences Of Fires On Ro-Ro Spaces And Special Category Spaces Of New And Existing*

-
- Ro-Ro Passenger Ships Proposals for improving the fire safety of ro-ro spaces*. London: International Maritime Organization (submitted by China).
- Koneck, & Galaj. (2017). Flame transfer through the external walls insulation of the building during a fire. *Procedia Engineering*, 172, 529 - 535.
- NFPA. (1997). *Fire Protection Handbook. 18th Edition*. Quincy, MA: National Fire Protection Association.
- Pluinage, & Sedmak. (2008). Security and reliability of damaged structures and defective materials. *Proceedings of the NATO Advanced Research Workshop on Security and reliability of damaged structures and defective materials*.
- SFPE. (2002). *Handbook of Fire Protection Engineering, 3rd Edition*.
- Vanem, E., & Skjong, R. (2004). Fire and Evacuation Risk Assessment for Passenger Ships. *Proceedings of the 10th International conference on Fire Science and Engineering, Interflam 2004*.

A1 ANNEXES:

A1.1 Data from fire containment HazId

The resulting tabulation of fire containment hazards and risk control measures is documented below. In the fourth column (*), a notation was made for the type of ro-ro space considered, namely open ro-ro space (O), closed ro-ro space (C) or weather deck (W).

Function	Desired properties	Affecting conditions	*	Failure mode	Effect	Potential safety measures	Comments
Fire/flame integrity	Prevention of spread of flames and hot smoke	Openings	CO	Openings of ro-ro space (in sides or at ends) too close to openings/windows/combustible materials/air inlet in spaces above.	Fire spread through ro-ro space openings, likely to spaces above the ro-ro space.	<ul style="list-style-type: none"> * Permanent closure of side openings on ro-ro decks. * Closure of side openings upon fire alarm. (shutters) * Sprinkler above openings. * Design with sufficient distance to areas prone to fire spread (windows, openings, combustible materials, air inlet, etc.) * Amendment forbidding all open ro-ro spaces. * Closure of openings at ends. * Sub-division between space with openings (closed space) and space without openings (weather deck, mooring station, etc.). 	
<i>Why: Avoid fire/flame spread through openings/cracks</i>	Heat resistant boundaries (not prone to crack/open upon fire/heat exposure)	Penetrations	CO	Holes cut in the deck or bulkhead which are not properly sealed, often retrofits in order to make penetrations for cables, pipes, ducts etc.	Fire spread to spaces adjacent to the ro-ro space.	<ul style="list-style-type: none"> * Education to increase awareness amongst crew of the potential consequences of leaving weaknesses/holes in divisions. * Develop procedures for installation, inspection and maintenance of penetrations. * Documentation on how planned work affects the fire integrity of boundaries (before work is initiated) and control of installation afterwards. * Regular inspection of fire zone boundaries by authority. 	Guarantee of boundary integrity should already be made by crew and class already inspects fire zones. (issue with survey, work, visit)

<i>Keep the fire in the space of origin</i>	Boundaries without openings	Doors	CO	Openings allowing fire to develop	Increased fire development and impossibility to achieve self-extinguishment/reduced fire development	<ul style="list-style-type: none"> * Permanent closure of openings on ro-ro decks. * Closure of openings upon fire alarm. (shutters) * Amendment forbidding openings on ro-ro spaces. * Closure of openings at ends. * Sub-division between space with openings (closed space) and space without openings (weather deck, mooring station, etc.). 	Should openings be forbidden both in the side plating or also in the ends? Closed ro-ro spaces often also have openings (e.g. for mooring station) - should/can all openings be forbidden/taken away?
	Sufficient protection by penetrations	Available combustible materials above/adjacent to openings	CO	Explosion	Pressure peak causing cracks/openings and immediate/eventual fire spread	<ul style="list-style-type: none"> * Requirement to carry explosive cargo on weather deck or open deck. * Detection of gases in ro-ro spaces. * Sniffers monitoring potential explosive atmosphere. * EX classified equipment. * Active ventilation, increasing in case of detected hazardous gases. 	Many of the proposed safety measures already apply for dangerous goods (IMDG Code).
		Heat resistance of boundaries Doors kept open/held back	CO	Doors held back/kept open due to service, maintenance, firefighting, ignorance, etc.	Fire spread through openings to other parts of the ship.		
Function	Desired properties	Affecting conditions	*	Failure mode	Effect	Potential safety measures	Comments
Smoke integrity	Smoke tightness of division	Doors kept open/held back	CO	Non-smoke-tight boundaries, openings and penetrations.	Smoke propagation to adjacent spaces.	<ul style="list-style-type: none"> * Modification in the specification of the A-class test in the FTP Code, to integrate evaluation of smoke-tightness. * Integration of new requirement and associated test for smoke-tight divisions (e.g. for main fire zones). * Creation of under pressure in the ro-ro space. 	Fire test for fire boundaries does not evaluate the spread of smoke (as long as it does not result in fire spread/ignition of a cotton pad).

Why: <i>Prevention of fire casualty</i>	Smoke tight doors	Pressure differences	CO	Over pressure in the ro-ro space.	Smoke spread to the accommodation part of the ship (including crew quarters, bridge, evacuation station, etc.)	<ul style="list-style-type: none"> * Creation of under pressure in the ro-ro space by exhaust ventilation system for the ro-ro space. * Creation of over pressure in the accommodation part of the ship. * Extraction of smoke by ventilation system (Smoke Heat Exhaust Ventilation = SHEV) * Added fan and door in all stairways connecting the ro-ro space to the accommodation part of the ship, creating an "air lock". 	<p>SHEV could affect the performance of alternative extinguishing systems, such as "water mist".</p> <p>Over pressure in the stairways could allow not creating an over pressure in the whole accommodation. There are currently fans in stairways to create an over pressure, but they are generally dimensioned for a closed doors scenario. It would be beneficial if the design of fans in stairways was more conservative - also considering open doors during firefighting. Ro-ro space ventilation system components need to sustain high temperatures if it is to ventilate smoke and achieve an under pressure.</p>
			CO	Smoke filling in the whole ro-ro space.	Impossibility of firefighting due to visibility problems and smoke spread to accommodation in case doors are opened.	<ul style="list-style-type: none"> * Water curtains reducing smoke spread in the ro-ro space. * Textile curtain/smoke screen achieving sub-division of the ro-ro space. * Metal curtain achieving sub-division of the ro-ro space. 	<p>If sub-division is to be achievable below the transversal bulkheads, it will also be necessary to seal the holes in the beams above curtains/draft stoppers or to have a false deckhead below the transversals.</p> <p>Subdivision systems obstructing view (e.g. foldable walls creating and indenture to the space) during loading and unloading should be avoided due to personal safety.</p>
			All	Large amount of smoke escaping from openings in side plating, ends and from weather deck.	Smoke spread to people in the accommodation part of the ship or on embarkation deck as well as to machinery air inlets (e.g. to emergency generators), etc.	<ul style="list-style-type: none"> * Permanent closure of side openings on ro-ro decks. * Closure of side openings upon fire alarm. (shutters) * Amendment forbidding all open ro-ro spaces. * Closure of openings at ends. * Operation of the ship up in a beneficial direction, e.g. up against the wind to avoid smoke spread to the bridge. 	<p>It is not obvious how the ship should be navigated in the most beneficial way - a strategy for this needs to be developed for each specific ship - the important thing is that different scenarios have been identified and thought through.</p>
<i>Prevention of machinery breakdown</i>		Openings					
		Weaknesses in divisions' smoke tightness (holes, penetrations...)					

				* Safety distance between openings and LSA.	
W	Openings, cracks in divisions and by penetrations/doors etc. by weather deck.	Smoke spread from weather deck to the accommodation part of the ship.		<ul style="list-style-type: none"> * Fire monitors on weather deck. * Operation of the ship up in a beneficial direction, e.g. up against the wind to avoid smoke spread to the bridge. * Safety distance between openings and air inlets, openings etc. to accommodation space, to avoid smoke spread. 	Smoke integrity can be simply checked with smoke generators.
CO	Holes cut in the deck or bulkhead which are not properly sealed, often retrofits in order to make penetrations for cables, pipes, ducts etc.	Smoke spread to spaces adjacent to the ro-ro space.	<ul style="list-style-type: none"> * Education to increase awareness amongst crew of the potential consequences of leaving weaknesses/holes in divisions. * Develop procedures for installation, inspection and maintenance of penetrations. * Documentation on how planned work affects the fire integrity of boundaries (before work is initiated) and control of installation afterwards. * Regular inspection of fire zone boundaries by authority. 		
CO	Explosion	Pressure peak causing cracks/openings and immediate/eventual smoke spread	<ul style="list-style-type: none"> * Requirement to carry explosive cargo on weather deck or open deck. * Detection of gases in ro-ro spaces. * Sniffers monitoring potential explosive atmosphere. * EX classified equipment. * Active ventilation, increasing in case of detected hazardous gases. 		

Function	Desired properties	Affecting conditions	* Failure mode	Effect	Potential safety measures	Comments	
			CO	Doors held back/kept open due to service, maintenance, firefighting, ignorance, etc.	Smoke spread through openings to accommodation part of the ship.	<ul style="list-style-type: none"> * Creation of under pressure in the ro-ro space by exhaust ventilation system for the ro-ro space. * Creation of over pressure in the accommodation part of the ship. * Extraction of smoke by ventilation system (Smoke Heat Exhaust Ventilation = SHEV) * Added fan and door in all stairways connecting the ro-ro space to the accommodation part of the ship, creating an "air lock". 	
Heat insulation	Sufficient fire insulation	Fire development	CO	No/insufficient heat integrity of cables for critical functions (e.g. from bridge to ER, steering gear...)	Power loss, navigation impossibility, etc.	<ul style="list-style-type: none"> * A60 casing for cables affecting critical functions. * Re-routing of cables affecting critical functions. * Redundancy of cables affecting critical functions. * Outside routing of cables. 	Especially a problem for old ships.
	Cooling possibilities	Duration of fire	CO	Weaknesses in fire insulation due to maintenance work.	Fire spread to accommodation part of the ship.	<ul style="list-style-type: none"> * Education to increase awareness amongst crew of the potential consequences of leaving weaknesses/holes in divisions. * Develop procedures for installation, inspection and maintenance of penetrations. * Documentation on how planned work affects the fire integrity of boundaries (before work is initiated) and control of installation afterwards. * Regular inspection of fire zone boundaries by authority. 	Regulations are already in place as well as product certification, but hazards are still apparent in this area and differences exist between insulation types and sealings.
	Avoiding of heat bridges	Performance of fire insulation	CO	Non-existing insulation due to rules, i.e. requiring A0 and not A60.	Fire spread to adjacent ro-ro spaces.	<ul style="list-style-type: none"> * Requirement for A60 or more instead of A0 between ro-ro spaces. * Routine for boundary cooling from deck above (and deck below). 	

	Penetrations and openings	All High-intensity or long-lasting fire compared to the standard fire test curve in the FTP Code.	Fire spread to accommodation part of the ship.	<ul style="list-style-type: none"> * Increased fire insulation for ro-ro space boundaries, e.g. A-240 towards accommodation areas to ensure fire integrity and safety for passengers and crew in line with Safe Return to Port requirements. * Cooling of the boundaries of the space with the fire by fixed or manual means, from the deck above and the deck below. * Increase of drenchers pump and water discharge capacity. * Connection of the drenchers supply pump to the emergency switchboard. * Certification and use of divisions achieving the hydrocarbon (HC) curve instead of the standard fire curve (ISO 834), since the hydrocarbon curve better covers the fire sources on deck. * Separation (600 mm?) of cargo every X meters to ensure evacuation and avoid fire spread. * Water curtains sub-dividing/reducing fire development in the ro-ro space (longitudinally or transversally). * Textile curtain/screen achieving sub-division of the ro-ro space and avoiding fire development (longitudinally or transversally). * Metal curtain achieving sub-division of the ro-ro space and avoiding fire development (longitudinally or transversally). 	Connection of the drencher supply pump to the emergency switchboard requires high capacity generators.
	Condition of insulation Heat bridges and weaknesses in heat insulation capacity	All No possibility for boundary cooling.	Fire spread to adjacent spaces.	* Use of fire insulation.	
		W Weather deck is unprotected, and cooling possibilities are limited for weather deck with no possibility of local cooling.	Fire spread from weather deck to the accommodation part of the ship.	<ul style="list-style-type: none"> * Fire monitors on weather deck. * Operation of the ship up in a beneficial direction, e.g. up against the wind to avoid smoke spread to the bridge. * Safety distance between openings and air inlets, openings etc. to accommodation space, to avoid smoke spread. * Insulation of deck from below. * Fixed boundary cooling. 	

		CO	Heat barriers and insufficient heat insulation capacity of penetrations and doors (e.g. risk for fire spread at watertight doors, which have poor insulation capacity).	Fire spread from ro-ro space to the accommodation part of the ship.	<ul style="list-style-type: none"> * Use of water-tight doors which achieve at least A-0 (i.e. not A-60 doors with removed insulation). * Prohibition of keeping combustible materials by water-tight doors. * Ensure that the fire integrity is correct/in accordance with requirements and maintained, also for hatches, doors, etc. 	
		CO	Holes cut in the deck or bulkhead which are not properly sealed, often retrofits in order to make penetrations for cables, pipes, ducts etc.	Fire spread to spaces adjacent to the ro-ro space.	<ul style="list-style-type: none"> * Education to increase awareness amongst crew of the potential consequences of leaving weaknesses/holes in divisions. * Develop procedures for installation, inspection and maintenance of penetrations. * Documentation on how planned work affects the fire integrity of boundaries (before work is initiated) and control of installation afterwards. * Regular inspection of fire zone boundaries by authority. 	
		CO	Explosion	Pressure peak causing cracks/openings/deteriorated fire insulation and immediate/eventual heat spread.	<ul style="list-style-type: none"> * Requirement to carry explosive cargo on weather deck or open deck. * Detection of gases in ro-ro spaces. * Sniffers monitoring potential explosive atmosphere. * EX classified equipment. * Active ventilation, increasing in case of detected hazardous gases. 	
		CO	Fire insulation in ro-ro spaces is vulnerable and exposed.	Broken/openings in fire insulation, allowing fire spread.	<ul style="list-style-type: none"> * Information to truck drivers and loaders on vulnerable and exposed areas. * Protective metal sheet covering the insulation. 	

A1.2 Data from evacuation fire Hazld

The resulting tabulation of evacuation fire hazards and risk control measures is documented below. In the fourth column (*), a notation was made for the type of ro-ro space considered, namely open ro-ro space (O), closed ro-ro space (C) or weather deck (W).

Function	Desired properties	Affecting conditions	*	Failure mode	Effect	Potential safety measures	Comments
Protection form heat	Sufficient heat integrity of LSA	LSA position	CO	High-intensity or long-lasting fire compared to the standard fire test curve in the FTP Code.	Heat spread to escape routes or embarkation station part of the ship.	<ul style="list-style-type: none"> * Provision of active sprinkler system for embarkation stations, helicopter pick-up station/deck, etc. and procedures for boundary cooling. * Provision of fire hose connections at embarkation stations, helicopter pick-up station/deck. * Increased fire insulation towards evacuation and embarkation stations, e.g. A-240 to ensure fire integrity and safety in line with Safe Return to Port requirements. * Certification and use of divisions achieving the hydrocarbon (HC) curve instead of the standard fire curve (ISO 834), since the hydrocarbon curve better covers the fire sources on deck. * Alternative assembly/evacuation station. * Increased protection of assembly stations. 	
<i>Why: Ensure usability of LSA, embarkation station and escape routes.</i>	No heat exposure	Embarkation station layout	CO	No/insufficient heat integrity of cables for critical functions (e.g. from bridge to ER, steering gear...)	Power loss, black-out, navigation impossibility, etc., e.g. causing impossibility to navigate upwind or in a way which avoids smoke to embarkation station.	<ul style="list-style-type: none"> * A60 casing for cables affecting critical functions. * Re-routing of cables affecting critical functions. * Redundancy of cables affecting critical functions. * Outside routing of cables. * UPS 	Especially a problem for old ships.

		<p>Escape routes</p> <p>Heat bridges and weaknesses in heat insulation capacity</p> <p>Performance/condition of fire insulation</p> <p>Penetrations and openings</p> <p>Duration of fire</p> <p>Fire development</p>	CO	Weaknesses in fire insulation due to maintenance work etc.	Heat and fire spread to escape routes, evacuation and embarkation stations.	<ul style="list-style-type: none"> * Education to increase awareness amongst crew of the potential consequences of leaving weaknesses/holes in divisions. * Develop procedures for installation, inspection and maintenance of penetrations. * Documentation on how planned work affects the fire integrity of boundaries (before work is initiated) and control of installation afterwards. * Regular inspection of fire zone boundaries by authority. 	Regulations are already in place as well as product certification, but hazards are still apparent in this area and differences exist between insulation types and sealings.
Function (why?)	Desired properties (how?)	Affecting conditions (what affects?)	*	Failure mode	Effect	Potential safety measures	Comments
Protection from fire/flames	High quality fire seal at penetrations	Quality of fire seal at penetrations	CO	Guiding lines for rafts close to ro-ro space openings and thus exposed to ro-ro space fire.	Impossibility to guide/use rafts	<ul style="list-style-type: none"> * Design without raft guiding lines by openings. * Amendment forbidding ro-ro space side openings. * Safety distance between openings and LSA, guiding lines etc. 	MSC/Circ.1006 only applies to lifeboats. LSA means all kinds of lifeboats, life rafts, fast rescue boats; individual and collective. However, rescue boats are generally not considered.

<i>Why: Avoid fire/flame exposure through openings/cracks to LSA, escape routes, embarkation station, ...</i>	Fully sealed boundaries	Openings in side plating	CO	Passenger walkways exposed to ro-ro space fire through openings	Impossibility to use walkways, casualties	<ul style="list-style-type: none"> * Permanent closure of side openings on ro-ro decks. * Closure of side openings upon fire alarm. (shutters) * Sprinkler above openings. * Design with sufficient distance to areas prone to fire spread (windows, openings, combustible materials, air inlet, etc.) * Amendment forbidding all open ro-ro spaces. * Closure of openings at ends. * Sub-division between space with openings (closed space) and space without openings (weather deck, mooring station, etc.). * Increased integrity for strategic areas. 	Risks associated with evacuation from a ship delays the decision to abandon ship
		Location of LSA and embarkation station in relation to openings	CO	Evacuation impossible due to fire spread through large openings affecting LSA	Impossibility to use LSA	<ul style="list-style-type: none"> * Permanent closure of openings on ro-ro decks. * Closure of openings upon fire alarm. (shutters) * Amendment forbidding openings on ro-ro spaces. * Closure of openings at ends. * Sub-division between space with openings (closed space) and space without openings (weather deck, mooring station, etc.). * Fire monitors or fixed cooling above openings. * Safety distance between openings and LSA. * Clever routing/re-routing of the MES to keep them protected during embarkation. * Fixed nozzles by MES to provide cooling. 	
Function	Desired properties	Affecting conditions	*	Failure mode	Effect	Potential safety measures	Comments
Protection from smoke	No smoke affecting LSA, embarkation station, etc.	Openings in side plating	CO	Smoke spread through openings to LSA or embarkation station	Impossibility to use LSA or casualties	<ul style="list-style-type: none"> * Permanent closure of openings on ro-ro decks. * Closure of openings upon fire alarm. (shutters) * Amendment forbidding openings on ro-ro spaces. * Closure of openings at ends. * Sub-division between space with openings (closed space) and space without openings (weather deck, mooring station, etc.). * Fire monitors or fixed cooling above openings. * Safety distance between openings and ventilation outlets to LSA. * Clever routing/re-routing of the MES to keep them protected during embarkation. * Navigation of the ship in a beneficial direction. 	

<i>Why: Prevention of fire casualty</i>		Position of LSA	CO	Smoke spread through ventilation outlets to LSA or embarkation station	Impossibility to use LSA or casualties	<ul style="list-style-type: none"> * Permanent closure of openings on ro-ro decks. * Closure of openings upon fire alarm. (shutters) * Amendment forbidding openings on ro-ro spaces. * Closure of openings at ends. * Sub-division between space with openings (closed space) and space without openings (weather deck, mooring station, etc.). * Fire monitors or fixed cooling above openings. * Safety distance between openings and ventilation outlets to LSA. * Clever routing/re-routing of the MES to keep them protected during embarkation. * Navigation of the ship in a beneficial direction. 	
		Location of embarkation station					
		Ventilation outlets					
		Wind					
		Direction of ship					
Function	Desired properties	Affecting conditions	*	Failure mode	Effect	Potential safety measures	Comments
<i>Quick evacuation and abandonment</i>			All	No possibility of evacuation of passengers when being alongside. Failure of provision of secondary means of conventional (not considering LSA) evacuation in foreign harbour (where gangways are not usable) - secondary to the stern ramp.	Impossibility to evacuate ship in foreign/emergency harbour. Passengers having to stay onboard for a long time, deployment of LSA in harbour with resulting injuries.	<ul style="list-style-type: none"> * Development of procedures for evacuation of the ship when being alongside (should be included in safe return to port procedures), using MES, helicopter, ramp, life-boats depending on the fire scenario. * Opening low in each ship side of the ship, providing means for evacuation together with the stern ramp. * Staircase system provided at port which can be used together with side openings. * Inflatable slide, built into the ship, providing safe evacuation from ship openings. 	If the stern ramp is blocked by the fire, it should still be possible to use the LSA, which would be quite safe in a harbour (calm). Nevertheless, experience/training has shown that there are still risks associated with use of LSA (especially for elderly, children and disabled). It could therefore still be reasonable to argue for a secondary means of "conventional" (walking off the ship type of) evacuation. Openings in ship sides should preferably be located relatively low/close to the quay (as is common on cruise vessels), but since foreign quays are considered it is not easy to determine a suitable height. Furthermore, tidal water should be

Why: Prevention of fire casualty					<p>considered. An opening height low to the water line which could allow evacuation to a floating dock or a normally low key side could still be most suitable.</p> <p>The pilot opening and the main deck are often connected, which makes such an opening unsuitable for evacuation in case of fire on the main deck.</p> <p>It could be difficult to require all/the ports to provide a generic staircase system and using a slide can be considered equivalent to launching LSA.</p> <p>It is different from ship to ship how easy it is to evacuate passengers safely when you are alongside.</p> <p>It can be impossible to use the ramp when evacuating passengers alongside.</p> <p>Secondary means of escape through ro-ro spaces - will they be safe in case of a fire in the space underneath?</p> <p>All current systems are difficult to deploy in heavy weather but in general the RFD is currently preferred over the Viking.</p> <p>LSA equipment design is not part of this project, however potential risks of a fire on ro-ro deck compromising the function or use of LSA equipment will be considered (see Fire integrity above).</p> <p>Should these activities be possible to manage simultaneously?</p>
	All	Heavy seas and launching of LSA	Impossibility to use LSA which is not compromised by ro-ro space fire	* Use and installation of LSA deployable in bad weather.	
	All	Capability to fight the fire can be lost on some ships when a decision for evacuation has been taken	Fast growing fire in ro-ro space, total loss of ship.	* Manning MES with only catering staff in order to continue boundary cooling (not preferable for life-boats and rafts).	

		All	Passenger management and control		* Crowd management training. * Multi-lingual instructions (skill of crowd manager).	
		All	Miscommunication with international crew		* Frequent and useful training, addressing communication and familiarization challenges. * Keeping the crew in charge of LSA operations in one nationality/native language.	
		All	Means for evacuation in case of capsizing		* Emergency equipment lockers are required by some Flags, which could also include lifting devices for a fire situation.	
		All	Fire during approach to port, when passengers are allowed on deck prior to berthing or during unloading/loading.	Casualties due to difficult evacuation, accessibility problems, poor evacuation routes on deck.	* Review of procedures for firefighting and evacuation of passengers from ro-ro space.	Fire in a ro-ro space full of passengers is the worst possible scenario.
		All	Fire in ro-ro space during loading or discharging, requiring evacuation of a deck full of people and no active detection system.	Time consuming evacuation.	* Training of crew in routines and for how to guide evacuation in case of such a scenario. * Separation (600 mm?) of cargo every X meters to ensure evacuation and avoid fire spread. * Water curtains sub-dividing/reducing fire development in the ro-ro space (longitudinally or transversally). * Textile curtain/screen achieving sub-division of the ro-ro space and avoiding fire development (longitudinally or transversally). * Metal curtain achieving sub-division of the ro-ro space and avoiding fire development (longitudinally or transversally).	There will be personnel on deck to assist in the evacuation and to guide passengers. Detection should reasonably be quick in case the deck is full of people. Even if it is not allowed, ships have been known to allow passengers to the deck while the ship is "under way", i.e. before the first mooring line is attached on quay side. The main reason is to attain quicker discharge, but not allowing passengers to enter the car deck before mooring lines are attached may also result in a lot of people on deck when discharge is initiated, which implies a major risk on its own. However, it should be noted that the regulation (SOLAS II-1/23.9) concerns "enclosed ro-ro deck" (which is not defined in SOLAS) and that the regulation was formulated with damage stability in mind, not fire safety.

			All Efficiency of evacuation and abandonment	* Development of efficient procedures and harmonization in the fleet.	Risks associated with evacuation from a ship delays the decision to abandon ship
			All Children and disabled	* Review of procedures for children and disabled.	

A1.3 Updated Main fire risk model (*Cargo RoPax – Newbuildings*)

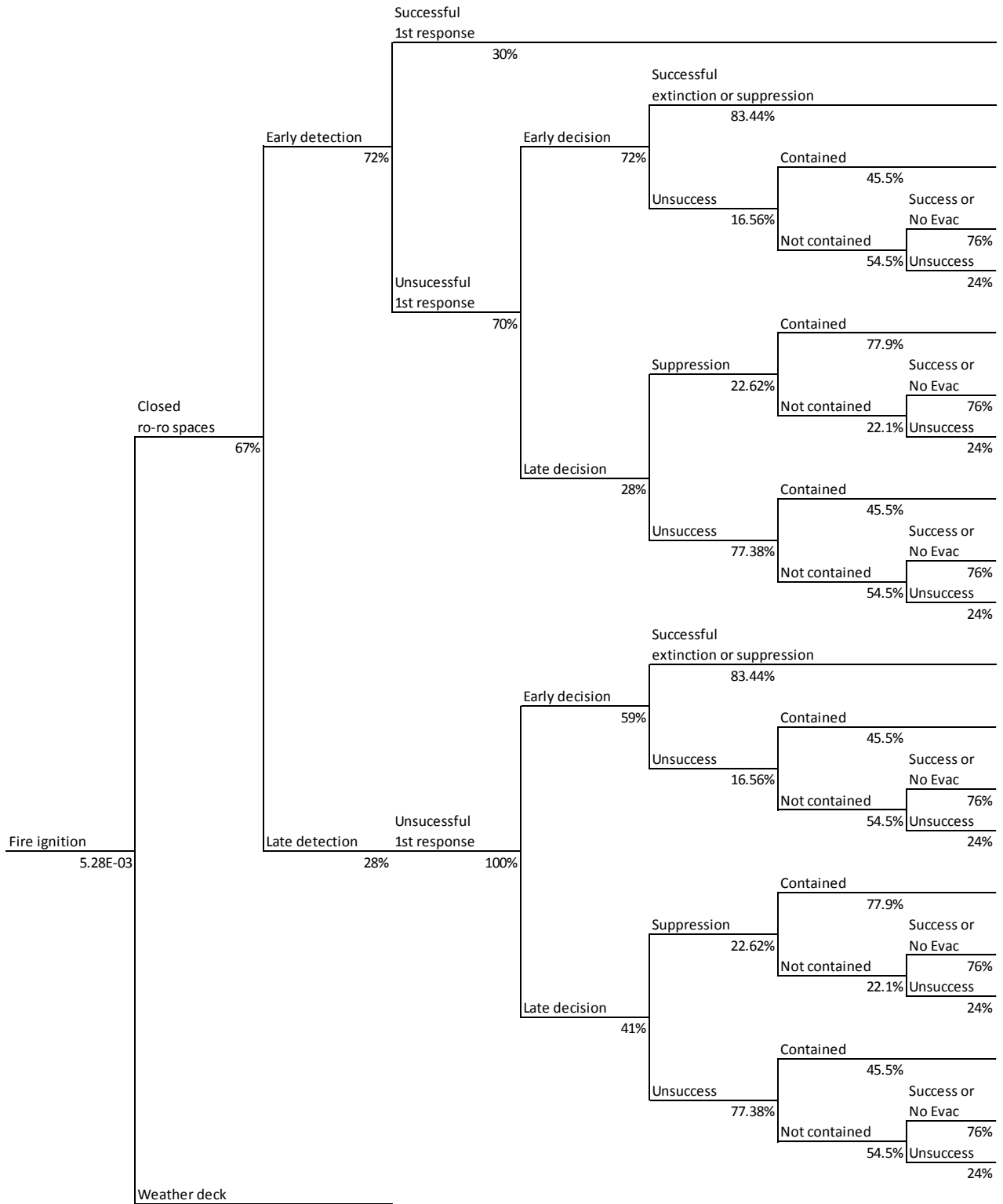

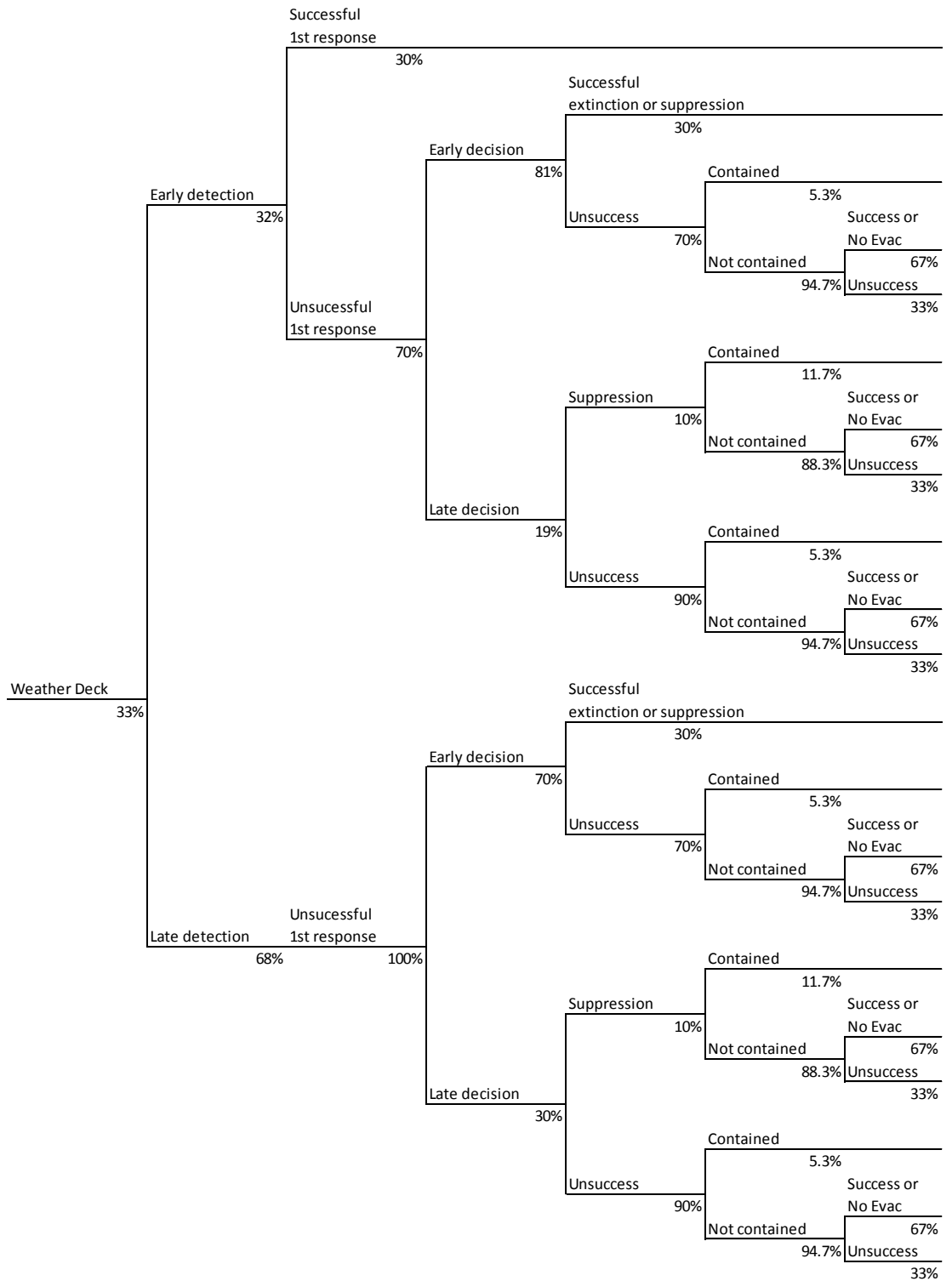

A1.4 Updated Main fire risk model (*Standard RoPax – Newbuildings*)

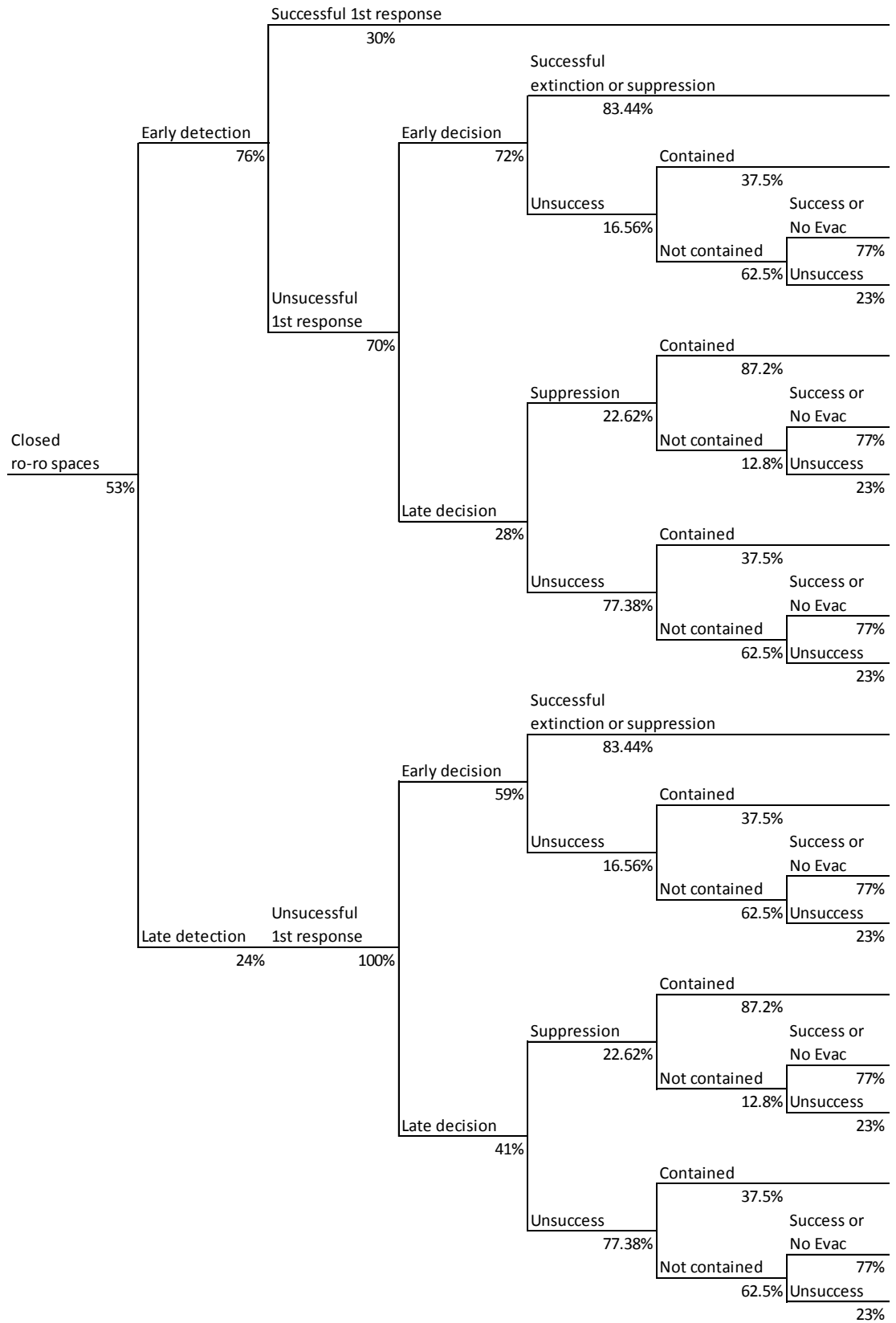

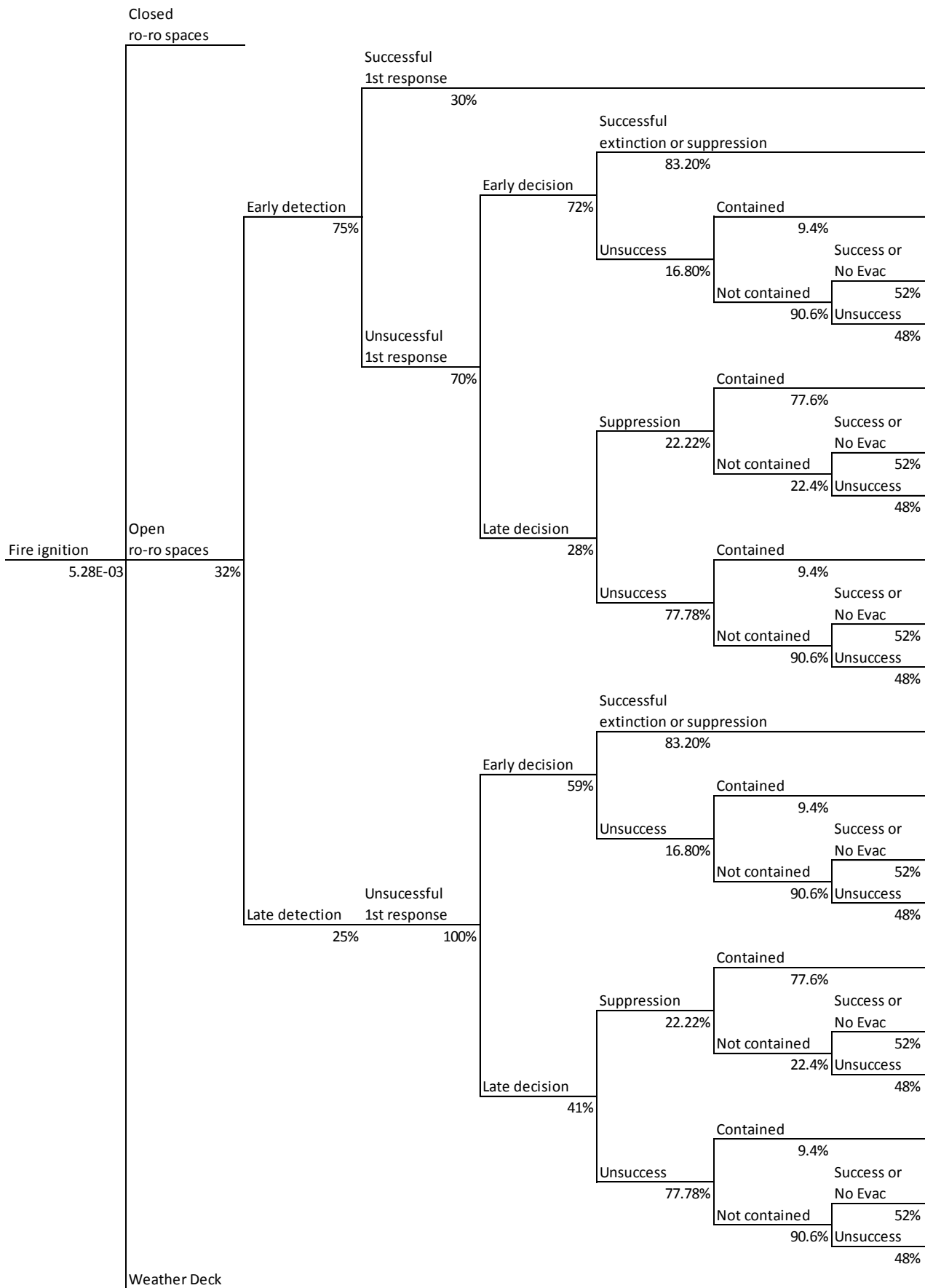

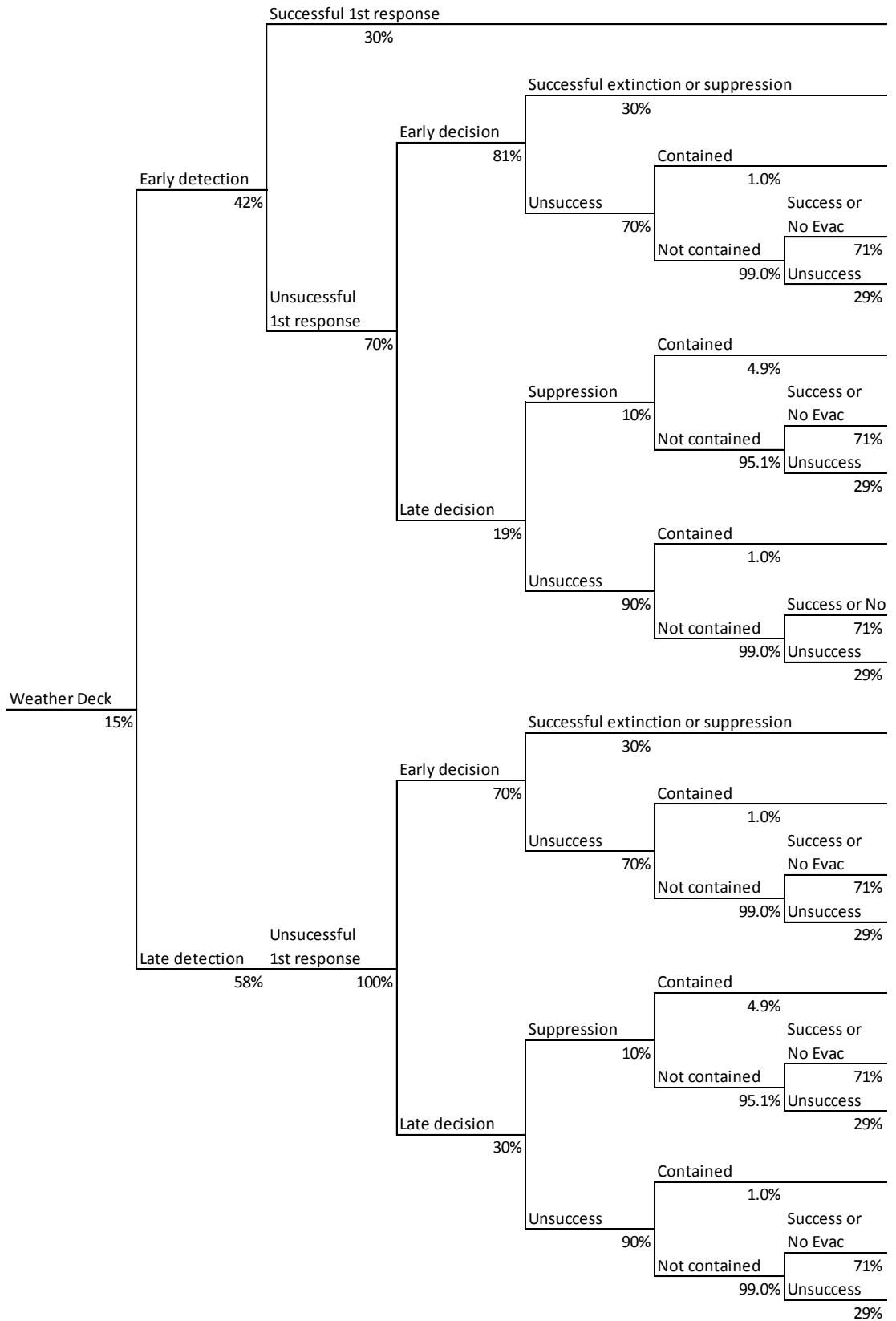

A1.5 Updated Main fire risk model (*Ferry RoPax – Newbuildings*)

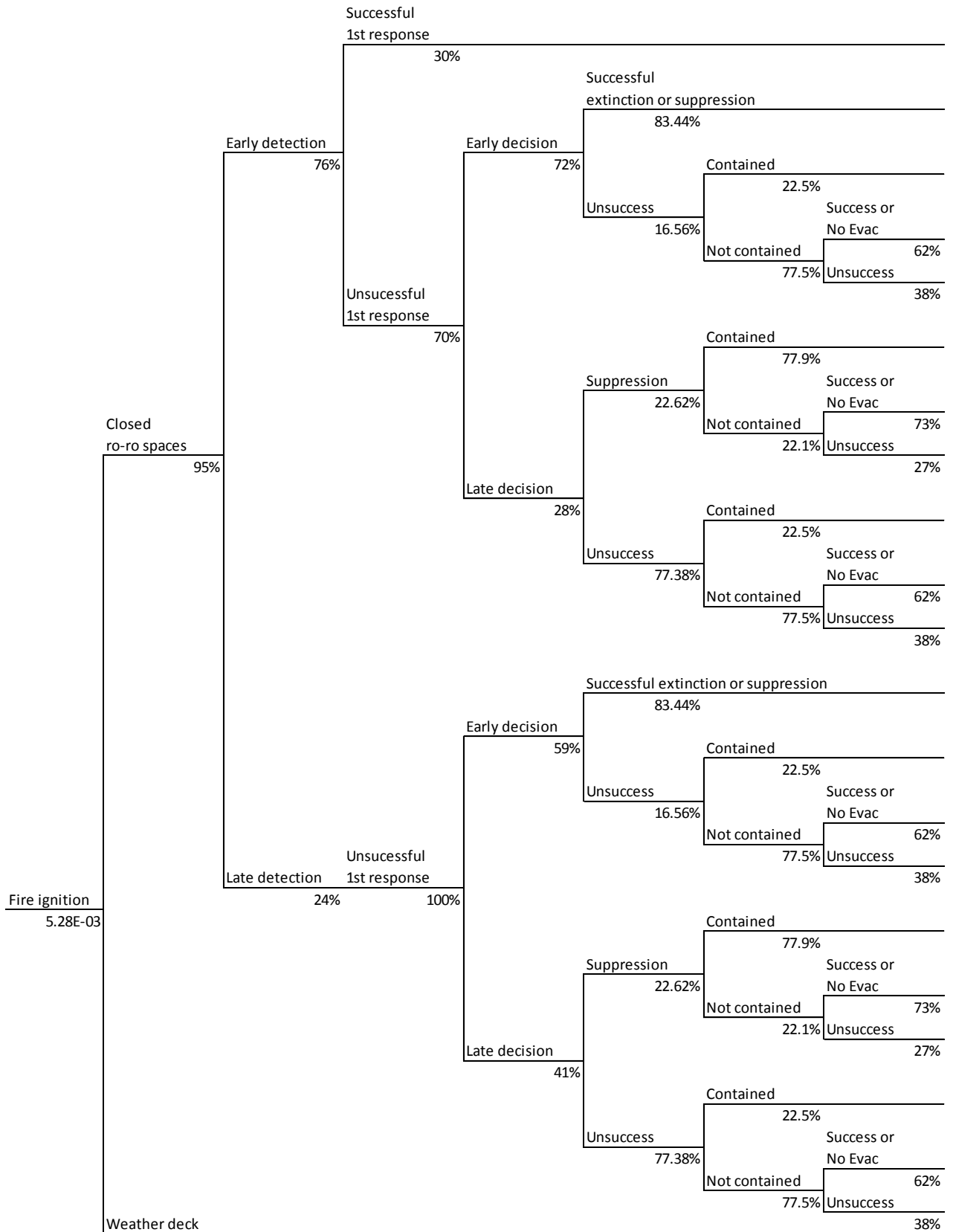

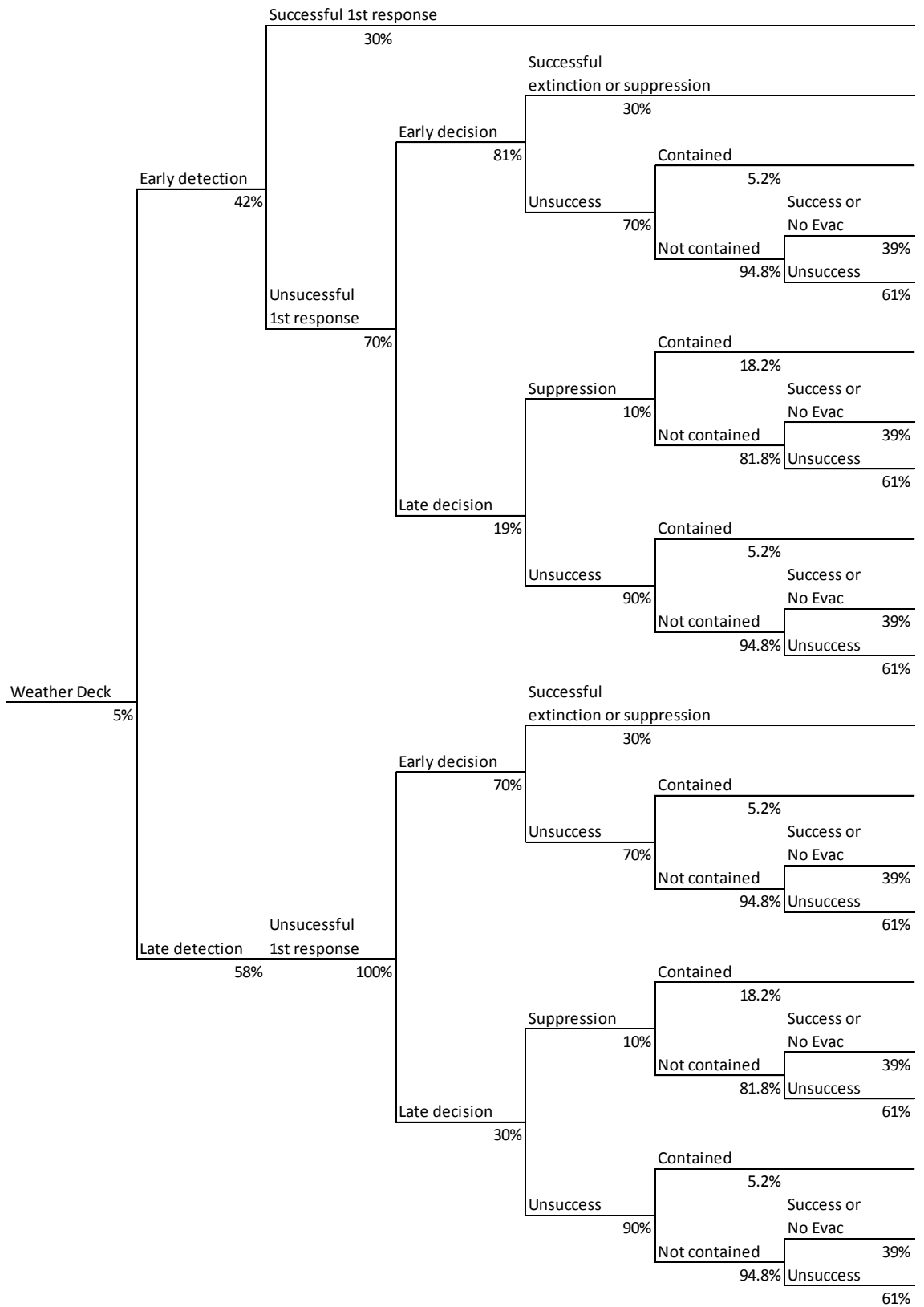

A1.6 Quantification of the Containment fault trees

The factors considered and used as background arguments for the quantifications are presented below, followed by the quantification results subsequently. The arguments are only presented for the *Standard RoPax* since this was the starting point for the quantifications. Rationales behind differences in quantifications with regard to other ship types (*Cargo* and *Ferry RoPax*) are elaborated in 9.3.3.2.

	Standard RoPax	
	Closed	Open
Failure of fire containment - Flame spread through openings - Openings	Very few openings give a low probability of failure. Failure in case of unsuccessful fire extinguishment was estimated to be 5 times higher than in case of successful extinguishment.	Failure was estimated 10 times higher than for the closed ro-ro space due to the presence of at least 10% of openings. Failure in case of unsuccessful fire extinguishment was estimated to be 10 times higher than in case of successful extinguishment, due to presence of air supply from openings.
Failure of fire containment - Flame spread through openings - Doors Open	Very low probability of failure because of presence of automatic closing devices or doors which are locked with an indicator for open doors in the wheelhouse. Failure in case of unsuccessful fire extinguishment estimated to be 5 times higher than in case of successful extinguishment.	Very low probability of failure because of presence of automatic closing devices or locked doors with an indicator for open doors in the wheelhouse. Failure in case of unsuccessful fire extinguishment was estimated to be 5 times higher than in case of successful extinguishment.
Failure of fire containment - Flame spread through openings - Non-sealed penetrations	Low probability due to prescribed procedures in case of work creating penetrations. In case of an unsuppressed fire, the probability was estimated 10 times higher. Indeed, non-sealed penetrations can be present everywhere in the space.	Same as for closed ro-ro space.
Failure of fire containment - Flame spread through openings - Cracks	The presence of cracks is intrinsically linked to the material then the probability of failure is 10 times lower than non-sealed penetrations. In case of an unsuppressed fire, the probability was estimated to be 10 times higher.	Same as for closed ro-ro space.
Failure of fire containment - Heat spread - Insulation failure - Insulation performance - Bad conditions	The probability of contamination of the fire insulation to such a degree that it causes heat spread was estimated to be 1.5%. A 5 times higher probability was assumed in case of a large fire, due to a bigger impact of the fire on the fire insulation.	The probability of contamination is slightly higher than for the closed ro-ro space because of the presence of openings. A 4 times higher probability in case of a large fire was assumed due to a bigger impact of the fire on the fire insulation.
Failure of fire containment - Heat spread - Insulation failure - Insulation performance - Damages / Gaps	Same as for <i>bad conditions</i> . In case of a large fire, the probability was estimated to be 2 times more than <i>Bad Conditions</i> because no fire insulation.	Same as for closed ro-ro space.

Failure of fire containment - Heat spread - Insulation failure - Insulation performance - Intensive/Long Fire	High probability of failure of insulation performance in case of unsuccessful extinguishment. In case of successful fire suppression, the heat wave will go anyway through the fire insulation but with a sharp reduction of intensity.	Same as for closed ro-ro space.
Failure of fire containment - Heat spread - Insulation failure - Heat bridge accepted as per SOLAS	The probability of failure due to heat bridges accepted in SOLAS was estimated low for a suppressed fire. Nevertheless, in case of an unsuppressed fire, the probability was assumed to be about 5 times higher due to the large amount of heat from the fire.	Same as for closed ro-ro space.
Failure of fire containment - Heat spread - Insulation failure - No insulation	Fire insulation is difficult to install everywhere as prescribed (a lot of recesses in the closed ro-ro space) or may not be technically installed as required. The probability of failure was estimated to be around 5% (low impact) in case of a suppressed fire. For the case of an unsuppressed fire, the probability was assumed to be 10 times higher.	The probabilities of failure were based on that for closed ro-ro space but assumed to slightly higher because of the possibility of a larger fire (well-ventilated fire for an open ro-ro space).
Failure of fire containment - Heat spread - Failure of boundary cooling	The total surface of the boundary that cannot be reached for boundary cooling was estimated to 5%. And in case of an unsuppressed fire, the reliability of boundary cooling and the difficulties of access gives a failure probability of 35%.	Same as for closed ro-ro space.
Failure of smoke containment - External smoke spread - Failure of navigation in a way to avoid effects on evacuation and spread to accommodations	This probability of failure was estimated a bit less than 10 times higher than for flames exiting through openings. In case of an unsuppressed fire, the probability was increased by 50%, which is the rough probability to have a worst-case wind direction.	This probability of failure was estimated to be a bit less than 50% higher than for flames exiting through openings. In case of an unsuppressed fire, the probability of smoke spread toward the accommodation part of the ship was represented by the worst-case wind direction.
Failure of smoke containment - External smoke spread - Spread through openings	This probability of failure was estimated to be 10 times lower than for the open ro-ro space.	In an open ro-ro space, in case of fire, smoke is present everywhere and the probability of smoke spreading through openings was assumed to be 10 times higher than flame spreading through openings. In case of an unsuppressed fire, the probability of smoke spreading through opening is close to 100%.
Failure of smoke containment - Internal smoke spread - Weakness of division smoke tightness - Doors failure - Gap - Damages	The probability of failure was assumed to be the same as for heat spread through damage/gaps. For the case of an unsuppressed fire, the probability was doubled due to a higher internal pressure from the fire.	For internal smoke spread, there is no difference between an extinguished and an unextinguished fire since smoke will spread easier externally. The probability of failure was assumed to be the same as heat spread through damage/gaps.

Failure of smoke containment - Internal smoke spread - Weakness of division smoke tightness - Doors failure - Gap - Prescriptive design according to the FTP code	Compared to the open ro-ro space, the closed space implies a higher over pressure due to fire. The probability of door failure related to smoke spread was doubled for the closed space compared to the open space because the pressure from the fire is larger in an enclosed space. In case of unsuppressed fire, the probability is taken 5 times higher.	Regardless (fire suppressed or not suppressed), the probability should be quite low because the smoke will likely spread through openings before it spreads through doors (difference in height between sill of openings and gaps under the doors).
Failure of smoke containment - Internal smoke spread - Weakness of division smoke tightness - Doors failure - Doors Open	The probability of smoke spread through an open door was assumed to be 5 times higher than the probability of flame spread through an open door.	The probability of smoke spread through an open door was assumed to be half compared to that for the closed ro-ro space, due to the presence of openings (smoke will spread primarily through side of aft openings before it spreads through an open door).
Failure of smoke containment - Internal smoke spread - Weakness of division smoke tightness - Failure of fire dampers	The ventilation system for the closed ro-ro space is required to be independent from other ventilation systems onboard and the fire dampers should be fail-safe. Fire dampers should be automat closed when the ventilation is closed. The probability of failure is than taken at 0.1%.	There are no fire dampers for open ro-ro spaces.
Failure of smoke containment - Internal smoke spread - Weakness of division smoke tightness - Failure of deck or bulkhead - Damages/Cracks	The probability of smoke spread was assumed to be 10 times higher than for the flame spread through damage/cracks.	For internal smoke spread, there is no difference between a suppressed and an unsuppressed fire because smoke will spread easier externally. The probability of smoke spread was estimated to be 5 times higher than for flame spread in case of damage/cracks.
Failure of smoke containment - Internal smoke spread - Weakness of division smoke tightness - Failure of deck or bulkhead - Not sealed penetration	The probability of smoke spread was considered to be only 5 times higher than for flame spread, due to the small amount of smoke that can spread through penetrations which are not sealed.	The probability of smoke spread was assumed to be only twice as high as for flame spread, due to the low amount of smoke that can spread through penetrations which are not sealed.
Failure of smoke containment - Internal smoke spread - Failure to create under pressure - Failure of the ventilation system	The probability of failure to create under pressure was considered to be very high (close to 100%) since the smoke production implies an over-pressure (no ventilation in a close ro-ro space in case of fire).	The probability of failure to create under pressure was considered to be about 25%, since the smoke production implies an over-pressure, which is however reduced by the presence of openings in open ro-ro spaces.

	Weather deck
Failure of fire containment - Flame spread	The probability of containment failure due to flame spread from a weather deck was estimated to be about 25%, mainly depending on the direction of wind (only one out of four directions was considered to imply a risk of flame spread from weather deck to the rest of the ship). In case of an unsuppressed fire, the probability was doubled due to the larger fire.
Failure of fire containment - Heat spread	Fire containment failure due to heat spread was estimated to be around 50%. Heat conduction from a fire on weather deck is mainly relevant downwards to a deck below or to an adjacent space (accommodation or ro-ro space), but an air gap (downwards) or fire insulation may be present to avoid fire spread. In case of an unsuppressed fire, the effect of fire insulation or an air gap was reduced and estimated to 25%. The probability of heat spread was therefore estimated to 75%. In case of a suppressed fire, the probability was estimated to be 50%.
Failure of smoke containment - Smoke spread	Probability of smoke spread is clearly high and close to 100%, regardless of a suppressed or unsuppressed fire. Smoke cannot be contained on a weather deck, per definition. In case of an unsuppressed fire, the probability is nevertheless higher than for a suppressed fire. The probability of smoke spread on weather deck causing containment failure was estimated to be 87% and 94% for a suppressed and unsuppressed fire, respectively.

	Newbuildings & Existing ships			
	Cargo RoPax			
	Closed		Weather	
	Success	Unsuccess	Success	Unsuccess
Failure of fire containment - Flame spread through openings – Openings	16.63%	20.06%		
Failure of fire containment - Flame spread through openings - Doors Open	0.06%	0.30%		
Failure of fire containment - Flame spread through openings - Non sealed penetrations	0.20%	2.33%		
Failure of fire containment - Flame spread through openings – Cracks	0.03%	0.40%		
Failure of fire containment - Heat spread - Insulation failure - Insulation performance - Bad conditions	1.67%	7.33%		
Failure of fire containment - Heat spread - Insulation failure - Insulation performance - Damages / Gaps	2.00%	13.00%		
Failure of fire containment - Heat spread - Insulation failure - Insulation performance - Intensive/Long Fire	4.83%	83.33%		
Failure of fire containment - Heat spread - Insulation failure - Heat bridge accepted as per SOLAS	3.47%	23.33%		
Failure of fire containment - Heat spread - Insulation failure - No insulation	3.88%	46.25%		
Failure of fire containment - Heat spread - Failure of boundary cooling	4.08%	24.50%		
Failure of smoke containment - External smoke spread - Failure of navigation in a way to avoid effects on evacuation and spread to accommodations	1.58%	2.25%		
Failure of smoke containment - External smoke spread - Spread through openings	22.44%	25.24%		
Failure of smoke containment - Internal smoke spread - Weakness of division smoke tightness - Doors failure - Gap – Damages	1.95%	4.00%		
Failure of smoke containment - Internal smoke spread - Weakness of division smoke tightness - Doors failure - Gap - Prescriptive design according to the FTP code	4.00%	20.33%		
Failure of smoke containment - Internal smoke spread - Weakness of division smoke tightness - Doors failure - Doors Open	1.60%	1.40%		
Failure of smoke containment - Internal smoke spread - Weakness of division smoke tightness - Failure of fire dampers	1.33%	6.37%		
Failure of smoke containment - Internal smoke spread - Weakness of division smoke tightness - Failure of deck or bulkhead - Damages/Cracks	0.10%	2.00%		
Failure of smoke containment - Internal smoke spread - Weakness of division smoke tightness - Failure of deck or bulkhead - Not sealed penetration	0.10%	9.00%		

Failure of smoke containment - Internal smoke spread - Failure to create under pressure - Failure of the ventilation system	60.67%	62.83%		
Failure of fire containment - Flame spread			16.33%	31.50%
Failure of fire containment - Heat spread			36.17%	51.33%
Failure of smoke containment - Smoke spread			78.00%	84.00%

	Newbuildings & Existing ships					
	Standard RoPax				Weather	
	Closed		Open		Success	Unsuccess
	Success	Unsuccess	Success	Unsuccess	Success	Unsuccess
Failure of fire containment - Flame spread through openings - Openings	0.75%	4.83%	8.75%	70.00%		
Failure of fire containment - Flame spread through openings - Doors Open	0.20%	1.00%	0.07%	0.83%		
Failure of fire containment - Flame spread through openings - Non sealed penetrations	0.20%	2.33%	0.16%	2.17%		
Failure of fire containment - Flame spread through openings - Cracks	0.03%	0.40%	0.08%	0.40%		
Failure of fire containment - Heat spread - Insulation failure - Insulation performance - Bad conditions	1.67%	7.33%	2.50%	9.50%		
Failure of fire containment - Heat spread - Insulation failure - Insulation performance - Damages / Gaps	2.00%	13.00%	1.83%	8.17%		
Failure of fire containment - Heat spread - Insulation failure - Insulation performance - Intensive/Long Fire	4.83%	83.33%	6.50%	83.33%		
Failure of fire containment - Heat spread - Insulation failure - Heat bridge accepted as per SOLAS	3.47%	23.33%	3.47%	20.00%		
Failure of fire containment - Heat spread - Insulation failure - No insulation	5.17%	61.67%	7.83%	71.67%		
Failure of fire containment - Heat spread - Failure of boundary cooling	5.17%	35.00%	5.83%	35.00%		
Failure of smoke containment - External smoke spread - Failure of navigation in a way to avoid effects on evacuation and spread to accommodations	6.33%	9.00%	13.33%	50.00%		
Failure of smoke containment - External smoke spread - Spread through openings	7.67%	11.00%	85.00%	98.33%		
Failure of smoke containment - Internal smoke spread - Weakness of division smoke tightness - Doors failure - Gap - Damages	1.95%	4.00%	1.22%	2.06%		
Failure of smoke containment - Internal smoke spread - Weakness of division smoke tightness - Doors failure - Gap - Prescriptive design according to the FTP code	4.00%	20.33%	2.00%	2.00%		
Failure of smoke containment - Internal smoke spread - Weakness of division smoke tightness - Doors failure - Doors Open	4.33%	4.67%	2.44%	2.44%		
Failure of smoke containment - Internal smoke spread - Weakness of division smoke tightness - Failure of fire dampers	1.33%	6.37%	0.00%	0.00%		

Failure of smoke containment - Internal smoke spread - Weakness of division smoke tightness - Failure of deck or bulkhead - Damages/Cracks	0.10%	2.00%	1.17%	1.17%		
Failure of smoke containment - Internal smoke spread - Weakness of division smoke tightness - Failure of deck or bulkhead - Not sealed penetration	0.10%	9.00%	5.67%	5.67%		
Failure of smoke containment - Internal smoke spread - Failure to create under pressure - Failure of the ventilation system	93.33%	96.67%	22.50%	26.67%		
Failure of fire containment - Flame spread					23.33%	45.00%
Failure of fire containment - Heat spread					51.67%	73.33%
Failure of smoke containment - Smoke spread					86.67%	93.33%

	Newbuildings & Existing ships			
	Ferry RoPax		Weather	
	Closed		Success	Unsuccess
	Success	Unsuccess	Success	Unsuccess
Failure of fire containment - Flame spread through openings - Openings	7.50%	17.77%		
Failure of fire containment - Flame spread through openings - Doors Open	0.30%	1.50%		
Failure of fire containment - Flame spread through openings - Non sealed penetrations	0.20%	2.33%		
Failure of fire containment - Flame spread through openings - Cracks	0.03%	0.40%		
Failure of fire containment - Heat spread - Insulation failure - Insulation performance - Bad conditions	1.67%	7.33%		
Failure of fire containment - Heat spread - Insulation failure - Insulation performance - Damages / Gaps	2.00%	13.00%		
Failure of fire containment - Heat spread - Insulation failure - Insulation performance - Intensive/Long Fire	4.83%	83.33%		
Failure of fire containment - Heat spread - Insulation failure - Heat bridge accepted as per SOLAS	3.47%	23.33%		
Failure of fire containment - Heat spread - Insulation failure - No insulation	5.17%	61.67%		
Failure of fire containment - Heat spread - Failure of boundary cooling	7.75%	52.50%		
Failure of smoke containment - External smoke spread - Failure of navigation in a way to avoid effects on evacuation and spread to accommodations	6.33%	9.00%		
Failure of smoke containment - External smoke spread - Spread through openings	26.79%	34.63%		
Failure of smoke containment - Internal smoke spread - Weakness of division smoke tightness - Doors failure - Gap - Damages	1.95%	4.00%		
Failure of smoke containment - Internal smoke spread - Weakness of division smoke tightness - Doors failure - Gap - Prescriptive design according to the FTP code	4.00%	20.33%		
Failure of smoke containment - Internal smoke spread - Weakness of division smoke tightness - Doors failure - Doors Open	6.50%	7.00%		
Failure of smoke containment - Internal smoke spread - Weakness of division smoke tightness - Failure of fire dampers	1.33%	6.37%		
Failure of smoke containment - Internal smoke spread - Weakness of division smoke tightness - Failure of deck or bulkhead - Damages/Cracks	0.10%	2.00%		
Failure of smoke containment - Internal smoke spread - Weakness of division smoke tightness - Failure of deck or bulkhead - Not sealed penetration	0.10%	9.00%		

Failure of smoke containment - Internal smoke spread - Failure to create under pressure - Failure of the ventilation system	96.13%	99.57%		
Failure of fire containment - Flame spread			25.67%	49.50%
Failure of fire containment - Heat spread			56.83%	80.67%
Failure of smoke containment - Smoke spread			43.33%	46.67%

A1.7 Risk control measures – Containment

RCM category	Risk Control Measure	Potential effect	Deck type
Best practice	Routine for boundary cooling from deck above (and potentially from deck below).	Heat barriers and insufficient heat insulation capacity of penetrations and doors will be counteracted (e.g. risk for fire spread at watertight doors, which have poor insulation capacity).	CO
Best practice	Information to truck drivers and stevedores on vulnerable and exposed areas.	Reduced risk of damaged fire insulation.	CO
Best practice	Design avoiding fire or smoke spread to adjacent areas (windows, openings, combustible materials, air inlet, etc.) by sufficient distance, sprinklers above openings, or other suitable solutions.	Achievement of the functional requirement to avoid fire spread from openings.	CO
Best practice	Ensure that the fire integrity is correct/in accordance with requirements and maintained, also for hatches, doors, etc.		CO
Boundary cooling	Connection of the drencher supply pump to the emergency switchboard.	Connection of the drencher supply pump to the emergency switchboard requires high capacity generators.	CO
Boundary cooling	Increased water discharge capacity (and drainage capacity) to allow the activation of a third drencher section (above -for boundary cooling- or on the deck with the fire to avoid fire spread)	Implies to increase the drencher pump capacity.	CO
Boundary cooling	Fixed boundary cooling on (weather) deck.	Weather deck is fairly unprotected and cooling possibilities are limited for weather deck with no possibility of local cooling.	W
Boundary cooling	Fire monitors on weather deck.	Weather deck is fairly unprotected and cooling possibilities are limited for weather deck with no possibility of local cooling.	W
Cables	A60 casing for cables affecting critical functions.	Cables for critical functions (e.g. from bridge to ER, steering gear...)	CO
Cables	Routing of cables outside of the ro-ro space.	When feasible	CO

Cables	Redundancy of cables affecting critical functions	Cables for critical functions (e.g. from bridge to ER, steering gear...)	CO
Closure	Closure (permanent) of side openings and openings at ends (on both "closed" and open decks).	Avoid inter alia large amount of smoke escaping from openings in side plating and ends and avoid fire to develop.	CO
Closure	Closure (permanent) of side openings on ro-ro decks (on both "closed" and open decks).	Avoid inter alia large amount of smoke escaping from openings in side plating and avoid fire to develop.	CO
Closure	Closure of side openings and openings at ends upon fire alarm. (shutters)	Avoid inter alia large amount of smoke escaping from openings in side plating and fire to develop.	CO
Closure	Closure of side openings upon fire alarm (on both "closed" and open decks). (shutters)	Avoid inter alia large amount of smoke escaping from openings in side plating and fire to develop. (In this case, detection is not improved)	CO
Completeness of boundaries	Further develop procedures for installation, inspection and maintenance of penetrations by documentation of how planned work affects the fire integrity of boundaries (before work is initiated) and control of installation afterwards.	Avoid any weaknesses in fire insulation due to maintenance work.	CO
Completeness of boundaries	Education to increase awareness amongst crew of the potential consequences of leaving weaknesses/holes in divisions.	Avoid any weaknesses in fire insulation due to maintenance work.	CO
Explosion	Active ventilation, increasing in case of detected hazardous gases (e.g. sniffers monitoring potential explosive atmosphere).	Avoid explosion leading to pressure peak causing cracks/openings/deteriorated fire insulation and immediate/eventual fire, smoke and heat spread Already apply for dangerous goods (IMDG Code).	CO
Explosion	EX classified equipment in closed and open ro-ro spaces.	Avoid explosion leading to pressure peak causing cracks/openings/deteriorated fire insulation and immediate/eventual fire, smoke and heat spread Already apply for dangerous goods (IMDG Code).	CO

Explosion	Requirement to carry explosive cargo on weather deck or open deck.	Avoid explosion leading to pressure peak causing cracks/openings/deteriorated fire insulation and immediate/eventual fire, smoke and heat spread Already apply for dangerous goods (IMDG Code).	CO
Fire insulation	Certification and use of divisions achieving the hydrocarbon (HC) curve instead of the standard fire curve (ISO 834).	Hydrocarbon curve could better cover the fire sources on deck. (Higher intensity fire compared to the standard fire test curve in the FTP Code.)	CO
Fire insulation	Requirement for fire insulation (at least) A30 instead of A0 between ro-ro decks.	Avoid/Delay fire spread	CO
Fire insulation	Increased fire insulation for ro-ro space boundaries, e.g. A-180 towards accommodation areas	Ensure fire integrity and safety for passengers and crew in line with Safe Return to Port requirements.	CO
Fire insulation	Protective metal sheet covering the insulation.	Avoid damage of fire insulation.	CO
Fire insulation	Use of fire insulation where boundary cooling is not possible (inaccessible spaces).	Avoid heat bridges.	COW
Fire insulation	Use of water-tight doors which actually achieve at least A-0.	Avoid risk of fire spread at watertight doors, which have poor insulation capacity (i.e. not A-60 doors with removed insulation).	CO
Smoke management	Operation of the ship in a beneficial direction, e.g. up against the wind to avoid smoke spread to the bridge.	It is not obvious how the ship should be navigated in the most beneficial way - a strategy for this needs to be developed for each specific ship - the important thing is that different scenarios have been identified and thought through.	OW

Smoke management	Creation of an "air lock" by added fan and door in all stairways connecting the ro-ro space to the accommodation part of the ship.	Over pressure in the stairways could allow not creating an over pressure in the whole accommodation. There are currently fans in stairways to create an over pressure, but they are generally dimensioned for a closed doors scenario. It would be beneficial if the design of fans in stairways was more conservative - also considering open doors during fire fighting. Ro-ro space ventilation system components need to sustain high temperatures if it is to ventilate smoke and achieve an under pressure.	CO
Smoke management	Creation of over pressure in the accommodation part of the ship.	Ro-ro space ventilation system components need to sustain high temperatures if it is to ventilate smoke and achieve an under pressure. This measure instead attains an over pressure in the accommodation part of the ship, to avoid smoke spread.	CO
Smoke management	Creation of under pressure in the ro-ro space by exhaust ventilation system for the ro-ro space to avoid smoke spread to accommodation through stairways etc.	Ro-ro space ventilation system components need to sustain high temperatures if it is to ventilate smoke and achieve an under pressure.	CO
Smoke tightness	Implementation of new test and requirement (already in place by A-class definition) for smoke-tight A-60 divisions for ro-ro space boundaries (i.e. for main fire zones).	Ensure that boundaries, openings and penetrations are smoke-tight and tested accordingly to avoid smoke propagation to adjacent spaces.	CO
Sub-division	Sub-division of the ro-ro space by metal, textile or similar curtains longitudinally (or central casing).	If sub-division is to be achievable below the transversal bulkheads, it will also be necessary to seal the holes in the beams above curtains/draft stoppers or to have a false deckhead below the transversals. Subdivision systems obstructing view (e.g. foldable walls creating an indenture to the space) during loading and unloading should be avoided due to personal safety.	CO

Sub-division	Sub-division of the ro-ro space by metal, textile or similar curtains longitudinally (central casing) and transversally every 80 m (by drencher sectioning)	If sub-division is to be achievable below the transversal bulkheads, it will also be necessary to seal the holes in the beams above curtains/draft stoppers or to have a false deckhead below the transversals. Subdivision systems obstructing view (e.g. foldable walls creating an indenture to the space) during loading and unloading should be avoided due to personal safety.	CO
Sub-division	Sub-division of the ro-ro space by metal, textile or similar curtains transversally every 40 m (by drencher sectioning)	If sub-division is to be achievable below the transversal bulkheads, it will also be necessary to seal the holes in the beams above curtains/draft stoppers or to have a false deckhead below the transversals. Subdivision systems obstructing view (e.g. foldable walls creating an indenture to the space) during loading and unloading should be avoided due to personal safety.	CO
Sub-division	Sub-division between ro-ro space without openings (closed space) and space with openings (weather deck, mooring station, etc.), e.g. by shutters		CO
Sub-division	Sub-division of the ro-ro space by water wall longitudinally (or central casing)	Assuming sufficient performance without cargo separation	CO
Sub-division	Sub-division of the ro-ro space by water wall longitudinally (central casing) and transversally every 80 m (in line with drencher sectioning)	Assuming sufficient performance without cargo separation	CO
Sub-division	Sub-division of the ro-ro space by water wall transversally every 40 m (in line with drencher sectioning)	Assuming sufficient performance without cargo separation	CO

A1.8 Ranking matrix – Containment (Newbuildings)

		Cost efficiency				
		Very Low	Low	Medium	High	Very High
Very High				<p>Closure of side openings and openings at ends (shutter at the end)</p> <p>Requirement for fire insulation (at least) A30 instead of A0 between ro-ro decks</p>	<p>Implementation of new test and requirement for smoke-tight A-60 divisions for ro-ro space boundaries</p> <p>Design avoiding fire or smoke spread to adjacent areas by sufficient distance, sprinklers above openings, or other suitable solutions.</p> <p>Fire monitors on weather deck.</p>	
High			<p>Closure of side openings and openings at ends upon fire alarm</p> <p>SD of the ro-ro space by WW transversally every 40 m (in line with drencher sectioning)</p> <p>Closure of side openings upon fire alarm</p> <p>Creation of an "air lock" by added fan and door in all stairways connecting the ro-ro space to the accommodation part of the ship.</p> <p>Certification and use of divisions achieving the HC curve in stead of the standard fire curve</p> <p>SD of the ro-ro space longitudinally (central casing) and transversally every 80 m (by drencher sectioning)</p> <p>SD of the ro-ro space transversally every 40 m (by drencher sectioning)</p>	<p>Connection of the drencher supply pump to the emergency switchboard.</p> <p>SD between ro-ro space without openings and space with openings</p> <p>Closure of side openings on ro-ro decks</p> <p>Increased thermal insulation for ro-ro space boundaries, e.g. A-180 towards accom. areas</p> <p>Routing of cables outside of the ro-ro space.</p> <p>A60 casing for cables affecting critical functions.</p>		
Medium			<p>SD of the ro-ro space longitudinally (or central casing).</p> <p>SD of the ro-ro space by WW longitudinally (central casing) and transversally every 80 m (in line with drencher sectioning)</p> <p>Creation of under pressure in the ro-ro space by exhaust ventilation system for the ro-ro space to avoid smoke spread to accommodation through stairways etc.</p> <p>Redundancy of cables affecting critical functions</p> <p>Increased water discharge capacity (and drainage capacity) to allow the activation of a third drencher section (above -for boundary cooling- or on the deck with the fire to avoid fire spread)</p> <p>SD of the ro-ro space by water wall longitudinally (or central casing)</p> <p>Use of fire insulation where boundary cooling is not possible (inaccessible spaces).</p> <p>Creation of over pressure in the accommodation part of the ship</p> <p>Ensure that the fire integrity is correct/in acc with req and maintained, also for hatches, doors, etc.</p> <p>Protective metal sheet covering the insulation.</p>	<p>Operation of the ship in a beneficial direction</p> <p>Routine for boundary cooling from deck above (and potentially from deck below)</p> <p>Fixed boundary cooling on (weather) deck</p> <p>Requirement to carry explosive cargo on weather deck or open deck.</p>		
Low	Active ventilation, increasing in case of detected hazardous gases (e.g. sniffers monitoring potential explosive atmosphere).		<p>Use of water-tight doors which actually achieve at least A-0.</p> <p>Further develop procedures for installation, inspection and maintenance of penetrations by documentation of how planned work affects the fire integrity of boundaries (before work is initiated) and control of installation afterwards.</p> <p>EX classified equipment in closed and open ro-ro spaces.</p> <p>Education to increase awarness amongst crew of the potential consequences of leaving weaknesses/holes in divisions.</p> <p>Information to truck drivers and stevedores on vulnerable and exposed areas.</p>			
Very Low						

A1.9 Ranking matrix – Containment (Existing ships)

		Cost efficiency				
		Very Low	Low	Medium	High	Very High
Risk Red	Very High		<p>Fire monitors on weather deck.</p> <p>Design avoiding fire or smoke spread to adjacent areas by sufficient distance, sprinklers above openings, or other suitable solutions.</p> <p>Requirement for fire insulation (at least) A30 instead of A0 between ro-ro decks.</p> <p>Closure (permanent) of side openings and openings at ends.</p>	<p>Implementation of new test and requirement (already in place by A-class definition) for smoke-tight A-60 divisions for ro-ro space boundaries (i.e. for main fire zones).</p>		
	High	<p>Certification and use of divisions achieving the hydrocarbon (HC) curve in stead of the standard fire curve (ISO 834).</p>	<p>Connection of the drencher supply pump to the emergency switchboard.</p> <p>Closure of side openings and openings at ends upon fire alarm. (shutters)</p> <p>Closure (permanent) of side openings on ro-ro decks</p> <p>A60 casing for cables affecting critical functions.</p> <p>Closure of side openings upon fire alarm (shutters)</p> <p>Creation of an "air lock" by added fan and door in all stairways connecting the ro-ro space to the accommodation part of the ship.</p> <p>Increased thermal insulation for ro-ro space boundaries, e.g. A-180 towards accommodation areas</p> <p>SD of the ro-ro space longitudinally (central casing) and transversally every 80 m (by drencher sectioning)</p> <p>Routing of cables outside of the ro-ro space.</p> <p>SD of the ro-ro space by water wall transversally every 40 m (in line with drencher sectioning)</p> <p>SD of the ro-ro space transversally every 40 m (by drencher sectioning)</p>	<p>SD between ro-ro space without openings (closed space) and space with openings (weather deck, mooring station, etc.), e.g. by shutters</p>		
	Medium	<p>Creation of over pressure in the accommodation part of the ship.</p> <p>Increased water discharge capacity (and drainage capacity) to allow the activation of a third drencher section (above -for boundary cooling- or on the deck with the fire to avoid fire spread)</p> <p>Protective metal sheet covering the insulation.</p>	<p>SD of the ro-ro space by WW longitudinally (central casing) and transversally every 80 m (in line with drencher sectioning)</p> <p>Use of fire insulation where boundary cooling is not possible (inaccessible spaces).</p> <p>Fixed boundary cooling on (weather) deck.</p> <p>Requirement to carry explosive cargo on weather deck or open deck.</p> <p>Creation of under pressure in the ro-ro space by exhaust ventilation system for the ro-ro space to avoid smoke spread to accommodation through stairways etc.</p> <p>SD of the ro-ro space longitudinally (or central casing).</p> <p>Sub-division of the ro-ro space by water wall longitudinally (or central casing)</p> <p>Redundancy of cables affecting critical functions</p> <p>Ensure that the fire integrity is correct/in accordance with requirements and maintained, also for hatches, doors, etc.</p>	<p>Operation of the ship in a beneficial direction, e.g. up against the wind to avoid smoke spread to the bridge.</p> <p>Routine for boundary cooling from deck above (and potentially from deck below).</p>		
	Low	<p>EX classified equipment in closed and open ro-ro spaces.</p> <p>Active ventilation, increasing in case of detected hazardous gases (e.g. sniffers monitoring potential explosive atmosphere).</p>	<p>Further develop procedures for installation, inspection and maintenance of penetrations by documentation of how planned work affects the fire integrity of boundaries (before work is initiated) and control of installation afterwards.</p> <p>Use of water-tight doors which actually achieve at least A-0.</p> <p>Education to increase awarness amongst crew of the potential consequences of leaving weaknesses/holes in divisions.</p> <p>Information to truck drivers and stevedores on vulnerable and exposed areas.</p>			
	Very Low					

A1.10 Participants of the fire containment hazard identification workshop and their expertise

Hazld participants	Organization	Profession / Competence	Role / responsibility
Franz Evegren	RISE	Research Scientist in Fire Safety Engineering	Moderator
Michael Rahm	RISE	Director of the Fire Dynamics Department	
Pierrick Mindykowski	RISE	Research Scientist in Fire Safety Engineering	Scribe
J��rome Leroux	BV	Risk Analysis Engineer	WP Leader
Antoine Cassez	BV	Fire Safety Engineer	
J��r��me Faivre	BV	Rule Development Engineer	
St��phane Quievreux	BV	Technical Adviser for Fire & Safety	
Adrien Aubert	BV	Research Engineer in Fluid Dynamics and Heat Transfer	
Lisa Gustin	Stena	M.Sc. Naval Architect Fire safety strategy development	
Mattias Kjellberg	Stena	Manager Contact Operation, former Captain on RoPax	
Peter Holm	Stena	Chief Engineer at RoPax, special competence in containment and ventilation, onboard fire safety manager	
Sifis Papageorgiou	EMSA	Project Officer Ship Safety & Marine Equipment	Observer / Project officer
Serge Heyraud	French Flag	Principal surveyor – ro-ro passenger ships expert	Observer
Ronny Lange	German Flag	Maritime Safety Division, Federal Ministry of Transport and Digital Infrastructure	Observer
Oliver Vardy	Maritime & Coastguard Agency (UK)	Policy Lead – Fire Safety and Engineering	Observer

A1.11 Participants of the fire evacuation hazard identification workshop and their expertise

Hazld participants	Organization	Profession / Competence	Role / responsibility
Franz Evegren	RISE	Research Scientist in Fire Safety Engineering	Moderator
Michael Rahm	RISE	Director of the Fire Dynamics Department	
Pierrick Mindykowski	RISE	Research Scientist in Fire Safety Engineering	Scribe
J�rome Leroux	BV	Risk Analysis Engineer	WP Leader
Antoine Cassez	BV	Fire Safety Engineer	
J�r�me Faivre	BV	Rule Development Engineer	
St�phane Quievreux	BV	Technical Adviser for Fire & Safety	
Adrien Aubert	BV	Research Engineer in Fluid Dynamics and Heat Transfer	
Lisa Gustin	Stena Teknik	M.Sc. Naval Architect Fire safety strategy development	
Mattias Kjellberg	Stena RoRo	Manager Contact Operation, former Captain on RoPax	
Peter Holm	Stena Line	Chief Engineer at RoPax, special competence in containment and ventilation, onboard fire safety manager	
Sifis Papageorgiou	EMSA	Project Officer Ship Safety & Marine Equipment	Observer / Project officer
Serge Heyraud	French Flag	Principal surveyor – ro-ro passenger ships expert	Observer
Ronny Lange	German Flag	Maritime Safety Division, Federal Ministry of Transport and Digital Infrastructure	Observer
Oliver Vardy	Maritime & Coastguard Agency (UK)	Policy Lead – Fire Safety and Engineering	Observer

A2LIST OF ABBREVIATIONS

AB:	Able seaman
AFV:	Alternatively Fuelled Vehicles
BA:	Breathing Apparatus
CCTV:	Closed-Circuit Television
CFD:	Computational Fluid Dynamics
EMSA:	European Maritime Safety Agency
EN:	European Norm
EU:	European Union
FC:	Fuel Cell
FDS:	Fire Dynamics Simulator
FMEA:	Failure Mode and Effects Analysis
FSA:	Formal Safety Assessment
FSS:	International Code for Fire Safety Systems
FTP:	International Code for Application of Fire Test Procedures
GCAF:	Gross Cost of Averting a Fatality
GT:	Gross Tonnage
HazId:	Hazard Identification
HRR:	Heat Release Rate
IACS:	International Association of Classification Societies
IEC:	International Electrotechnical Commission
IMDG:	International Maritime Dangerous Goods Code
IMO:	International Maritime Organization
ISO:	International Organization for Standardization
LHF:	Low-Hanging Fruit
LM:	Lane Metre
LSA:	Life-Saving Appliances
MES:	Marine Evacuation System
MSC:	Maritime Safety Committee
MVZ:	Main Vertical Zone
NCAF:	Net Cost of Averting a Fatality
NPV:	Net Present Value
PLC:	Potential Loss of Cargo
PLL:	Potential Loss of Life
PLS:	Potential Loss of Ship
RCM:	Risk Control Measure
RCO:	Risk Control Option

SOLAS:	Safety of Life at Sea
SFPE:	Society of Fire Protection Engineers
SRtP:	Safe Return to Port
SSE:	Ship Systems and Equipment
TRL:	Technology Readiness Level
UI:	Unified Interpretation
UR:	Unified Recommendation
WD:	Weather Deck